

BÖLLHOFF

NEW

HELICOIL® Smart

The new generation of thread technology
for high-strength joints



the EVOLUTION

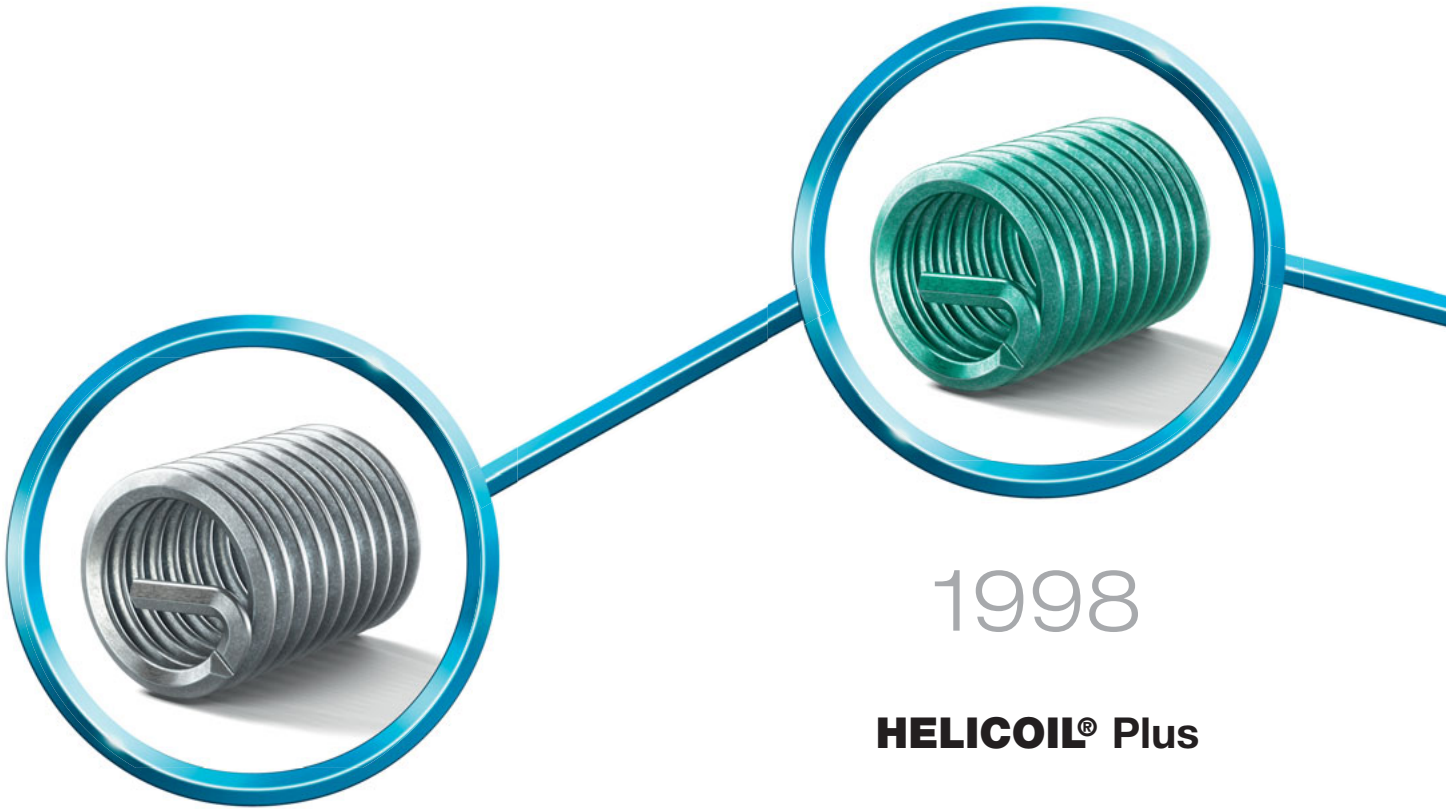

1954

HELICOIL® Classic

1998

HELICOIL® Plus

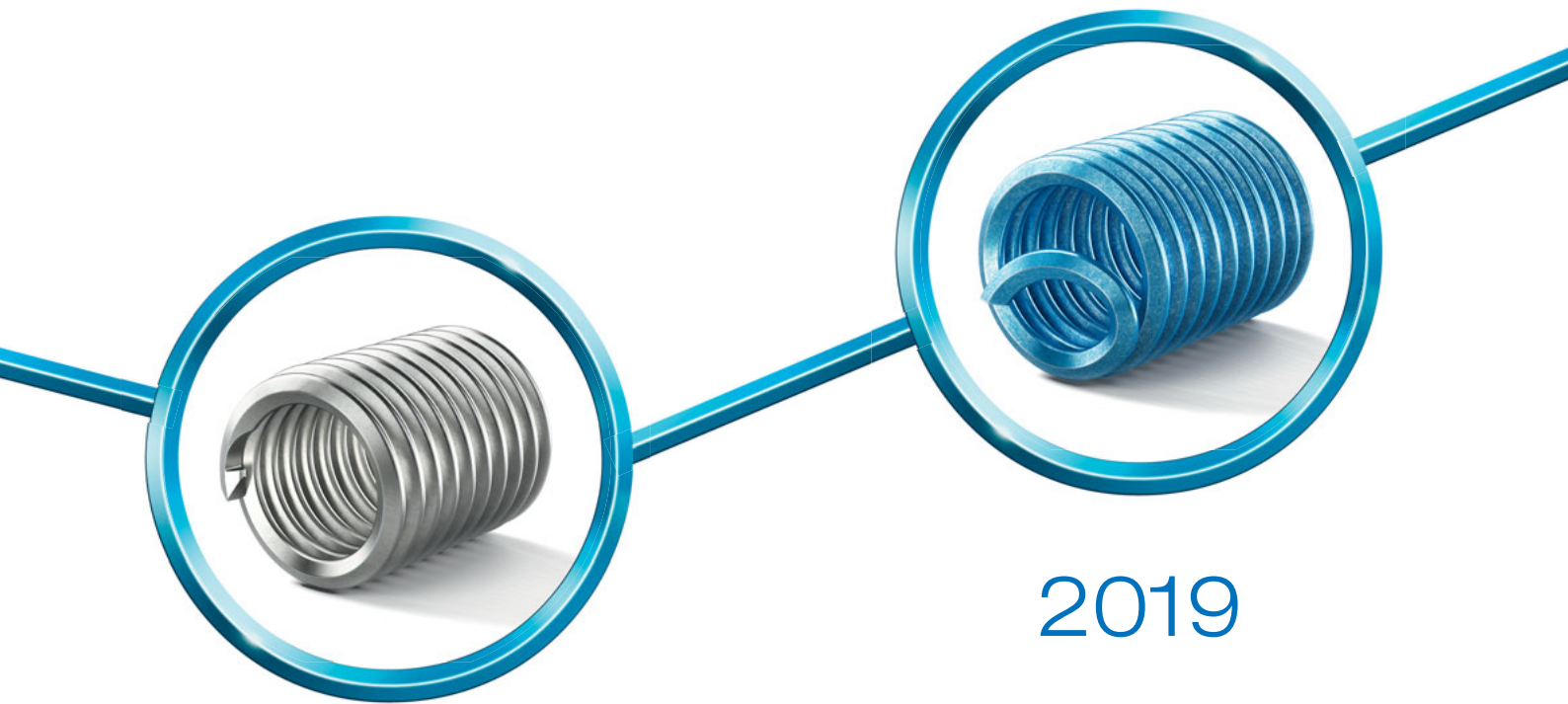

2010

HELICOIL® Tangfree

2019

HELICOIL® Smart

We continue to make product history.

HELICOIL® Smart – The next development stage of the HELICOIL® thread technology

The new HELICOIL® Smart is a further quantum leap in the HELICOIL® thread technology. A coil thread insert with tang which does not have to be broken off. The innovation: The installation mandrel bends it backward during spinning off and then compresses it.

This “smart” thread insert merges the advantages of the HELICOIL® Plus and the HELICOIL® Tangfree.

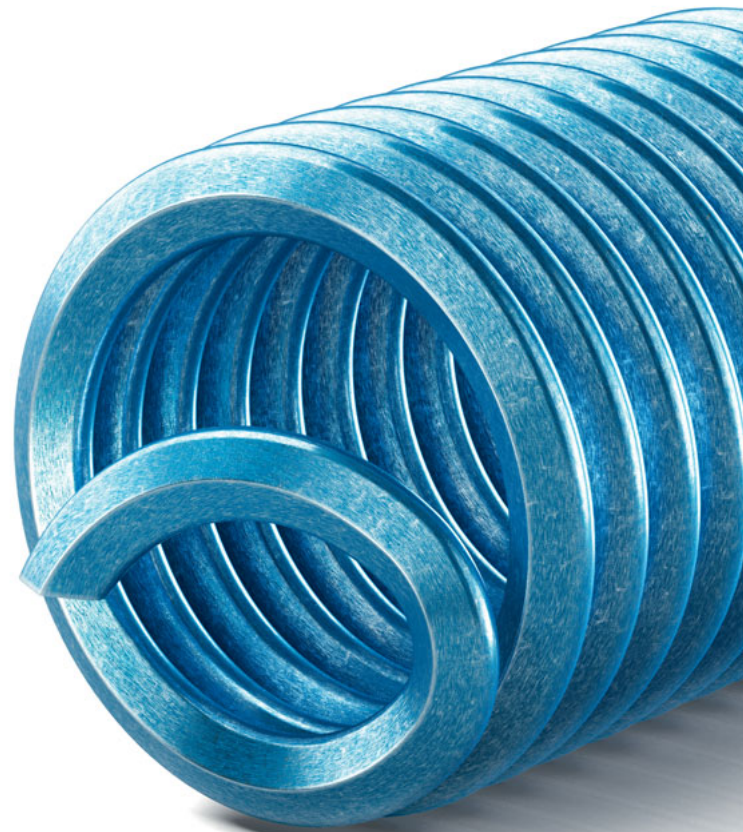
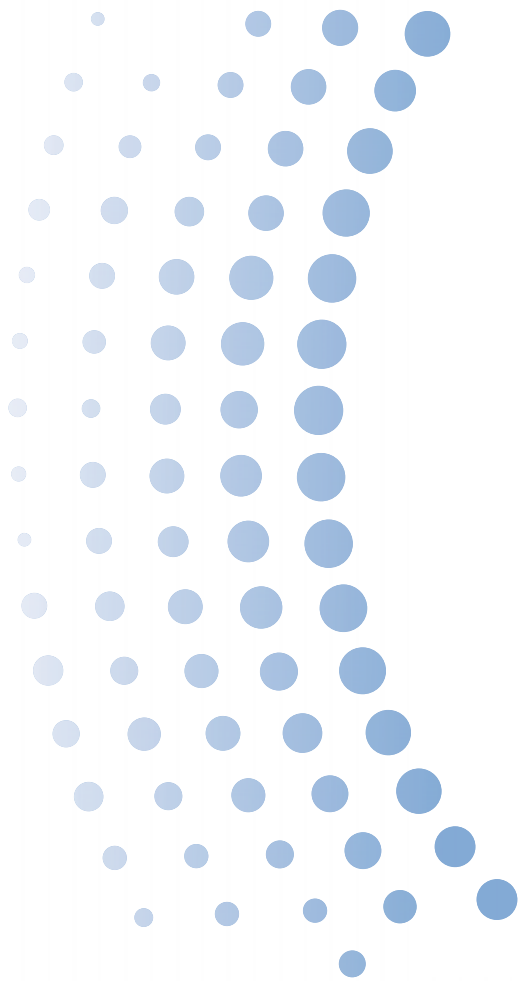

At a glance:

SMART

- Provided with a tang, but yet no tang
- No tang break – no tang removal
- No risks from tangs left in component

EFFICIENT

- Assembly times reduced by approx. 20 %
- Simplified quality assurance
- Permits blind holes of minimum depth – ideal for pre-assembled subassemblies etc.

SYSTEMATIC

- One installation mandrel with two functions – 2 in 1
- Fastener and installation tool from a single source
- The installation of the HELICOIL® Smart is fully automatable

COMPATIBLE

Identical specifications for HELICOIL® Smart holding threads as for the other HELICOIL® systems

INNOVATIVE

- Positioning and screwing in like a screw
- Optimum entry into the holding thread
- Easy handling

Of course, you also benefit from the well-known advantages of the established HELICOIL® thread technology.

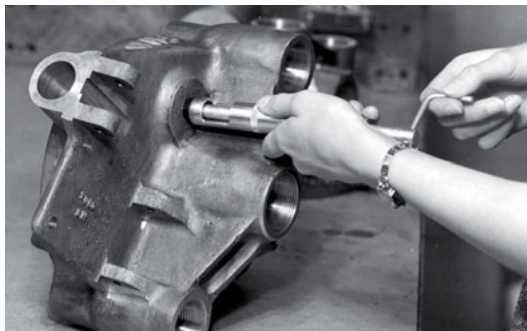

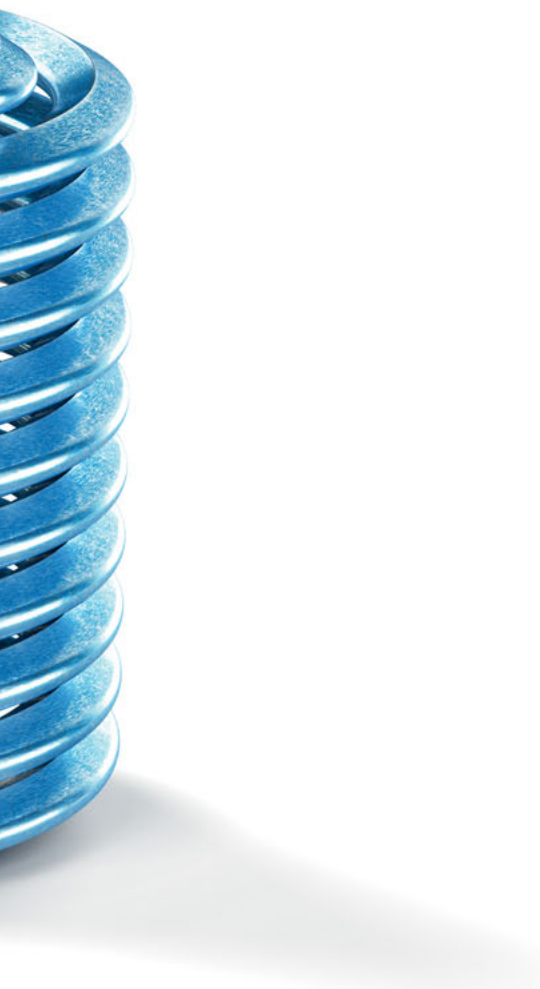

System modules – the fastener

Page

Technology	9
A close look at the advantages	10
Fields of application	12
Designs	14
Installation	16
Design guidelines	18
Technical data and item numbers	19

System modules – the tool

Pneumatic installation tool	22
Spare parts	24
Wear parts	25
Accessories	26
Extraction tool	27
Automation	27

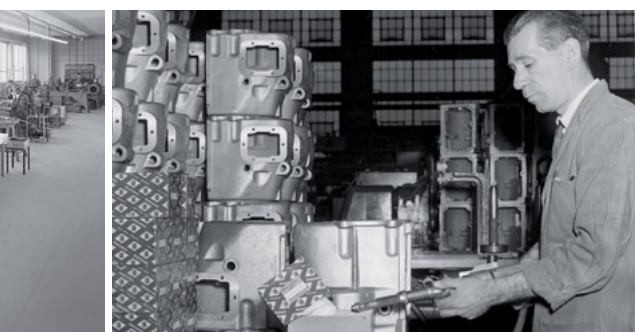



Can you imagine a world without screws? Even today, the screw is the most widely used fastening element for detachable joints. Optimised tightening methods and high-strength screws allow constant improvement. Considerably higher forces can be transmitted so that the dimension or total number of required screws can be reduced. However, only highly sustainable nut threads permit high-strength screw joints. This is where our HELICOIL® thread technology is used.

Your advantages – an overview:

- High thread loading
- Increased quality and value
- Wear-resistant, low and constant thread friction
- Strong
- Corrosion and temperature resistant
- Cost-effective
- Tight fit
- Screw loss protection – Screwlock variant
- Part of the circular economy*

Structural component – thread reinforcement and repair

HELICOIL® is thread reinforcement and repair. Threads are reinforced whenever low-strength materials (e.g. aluminium, aluminium-magnesium alloys and fibre-reinforced plastics) are used. The nut thread is wear-resistant even in cases of frequent use. HELICOIL® allows miniaturisation and lightweight construction for the development of production parts. The HELICOIL® thread insert has been tried and tested for more than 65 years and has become a widely used structural component.

Worldwide, HELICOIL® thread inserts are approved for economical and lasting repair of damaged or worn out threads. Apart from repair of valuable individual components, parts used in large-scale production which have been rejected due to faults during thread production can be reintegrated into the production process.

*“The circular economy is a model of production and consumption, which involves sharing, leasing, reusing, repairing, refurbishing and recycling existing materials and products as long as possible. In this way, the life cycle of products is extended.”

Source: www.europarl.europa.eu/... 07.10.2019

The new HELICOIL® Smart technology

The new HELICOIL® Smart is a further quantum leap in the HELICOIL® thread technology. A coil thread insert with tang which does not have to be broken off. The innovation: The installation mandrel bends it backward during spinning off and then compresses it. This smart thread insert merges the advantages of the HELICOIL® Plus and the HELICOIL® Tangfree.

The HELICOIL® Smart thread insert, which is made from a wire with rhombic profile, is also formed into an elastic spiral. As to the Free Running version, thread by thread it is a completely free running coarse thread. The result is a true-to-gauge internal thread including the last thread which is in every case threadable. It produces high-strength threads transferring forces from flank to flank into the holding thread. The special thread start, which has been adapted from the HELICOIL® Plus, allows to position it like a screw and screw it in. To screw in the thread insert, all you need is the Smart installation mandrel of similar size as a tap. Very special is the blade position control. Upon screwing-in, the blade has a pull-in function, whereas upon screwing-out, it turns into a bending and compression tool.

Like all other stages in the HELICOIL® evolution, the Smart system is also highly reliable and German and international property rights have been applied for.

Combined with the respective installation tools, the current innovation stage in the HELICOIL® technology is a perfect addition to the HELICOIL® product family.



Defective thread



Repaired thread

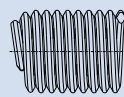
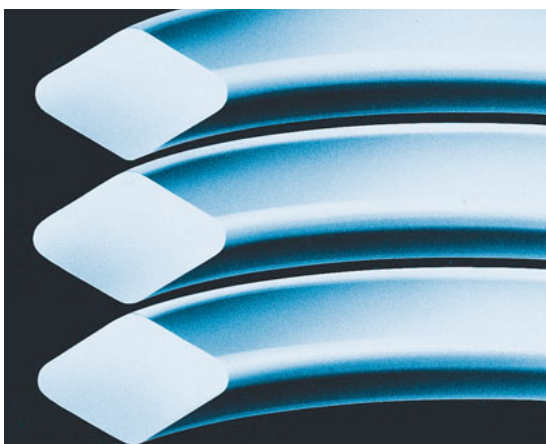

tang

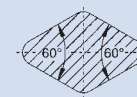
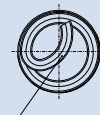

wire cross section

- R_m = min. tensile strength 1400 N/mm² (1 N/mm² equals 1 MPa)
- HV = Vickers hardness 425 HV 0.2 min.
- R_z = roughness depth approx. 2.5 μ m
- μ_G = reduced thread friction, results in increased preload-force F_v at constant tightening torque
- τ_t = reduced torsion stress in the screw shank

HELICOIL® Smart thread inserts – a close look at the advantages

Wear resistance

HELICOIL® Smart thread inserts are made of austenitic chrome-nickel steel (minimum tensile strength 1,400 N/mm²). The high surface quality of the rolled thread ensures a high-strength, wear-resistant thread with an extremely small and constant thread friction torque. Therefore, a higher, constant preload-force is achieved for repeated cycles at the same tightening torque. The utilisation of the yield point of high-strength screws is improved. Torsion stress is considerably reduced. Compared to tapped threads, the surface roughness of the HELICOIL® Smart is reduced by 90%.

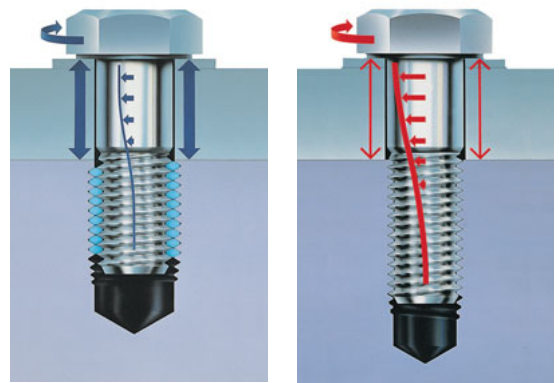

Strength

The elastic properties of the HELICOIL® Smart thread insert allow a uniform load and stress distribution. An optimum flank contact is achieved. Variable pitches and angles are compensated for over the entire length of the thread insert. Force transmission from bolt to nut thread is optimised. The quality of the screw joint is considerably increased – for static as well as dynamic operating loads.

Due to the improved distribution of the preload-force, the fatigue strength of dynamically loaded screws is increased. This is why the HELICOIL® is also suitable for use in threads in high-strength materials, e.g. steel or cast iron alloys.

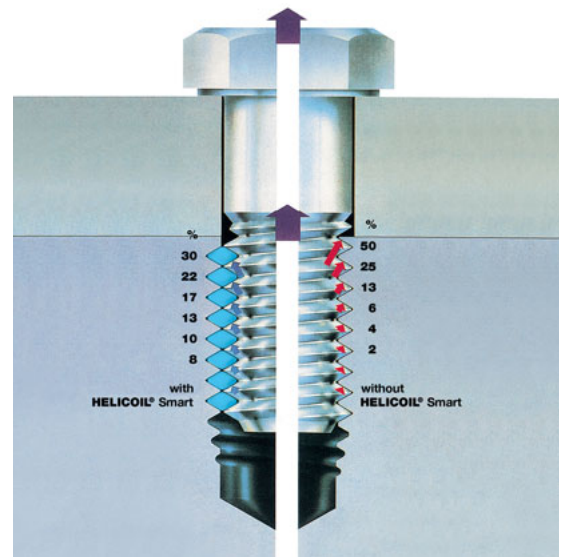

Corrosion and temperature resistance

The standard material of the HELICOIL® Smart prevents seizing of screws under environmental influences. HELICOIL® Smart thread inserts of nickel-based materials are available for thermally highly stressed screw joints. Elasticity and spring force remain constant.

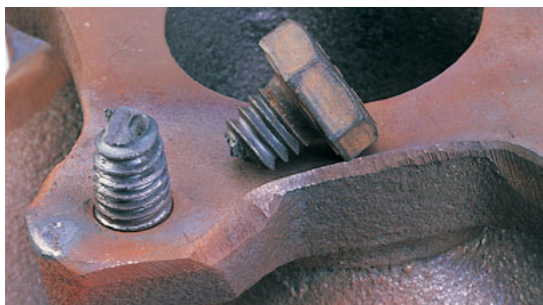

Tight fit

When not installed, the outside diameter of the HELICOIL® Smart exceeds the receiving thread by a defined amount. In combination with the high spring force of the material, this difference in dimension results in radial expansion and therefore in the tight and clearance-free fit in the nut thread. Additional locking elements or adhesive – as are common for fixed bushes – are therefore obsolete. If you use impact wrenches, please contact us. We will be happy to help you.



Friction

Thread friction and its scatter range can be reduced if a HELICOIL® is used. The dispersion range can be restricted. For example: If the thread friction value μ_G of a property class 10.9 carbon steel screw, screwed into a tapped nut thread ranges between 0.12 and 0.18, the μ_G values range between 0.11 and 0.13 if a coil thread insert is used. For a torque-controlled screw tightening application, the screw preload-force can be adjusted more precisely and the yield point of the screw utilised more efficiently. Simultaneously, the preload force is increased during screw breakage due to reduced torsional stress.

Downsizing

Engineers can choose almost any material. The HELICOIL® Smart corresponds to today's trend toward lightweight construction (e.g. aluminium and magnesium) because this method of thread reinforcement combines minimum space requirements and high strength. High-strength screws are therefore also perfectly suitable for low-shear materials. A reduced number of joints and smaller screw sizes save material, installation space and weight – at high fatigue strength. These are definite advantages of the HELICOIL® system.

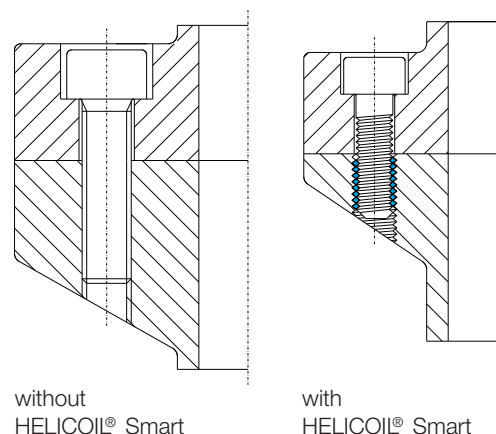

HELICOIL® Smart application areas

HELICOIL® Smart thread inserts create high-strength, stable joints in low-strength metal materials (lightweight design) to be used in diverse industries, such as:



Mechanical and plant engineering

Electrical industry

Automotive engineering and vehicle manufacturing

Tool design and construction

Telecommunication

Agricultural machinery

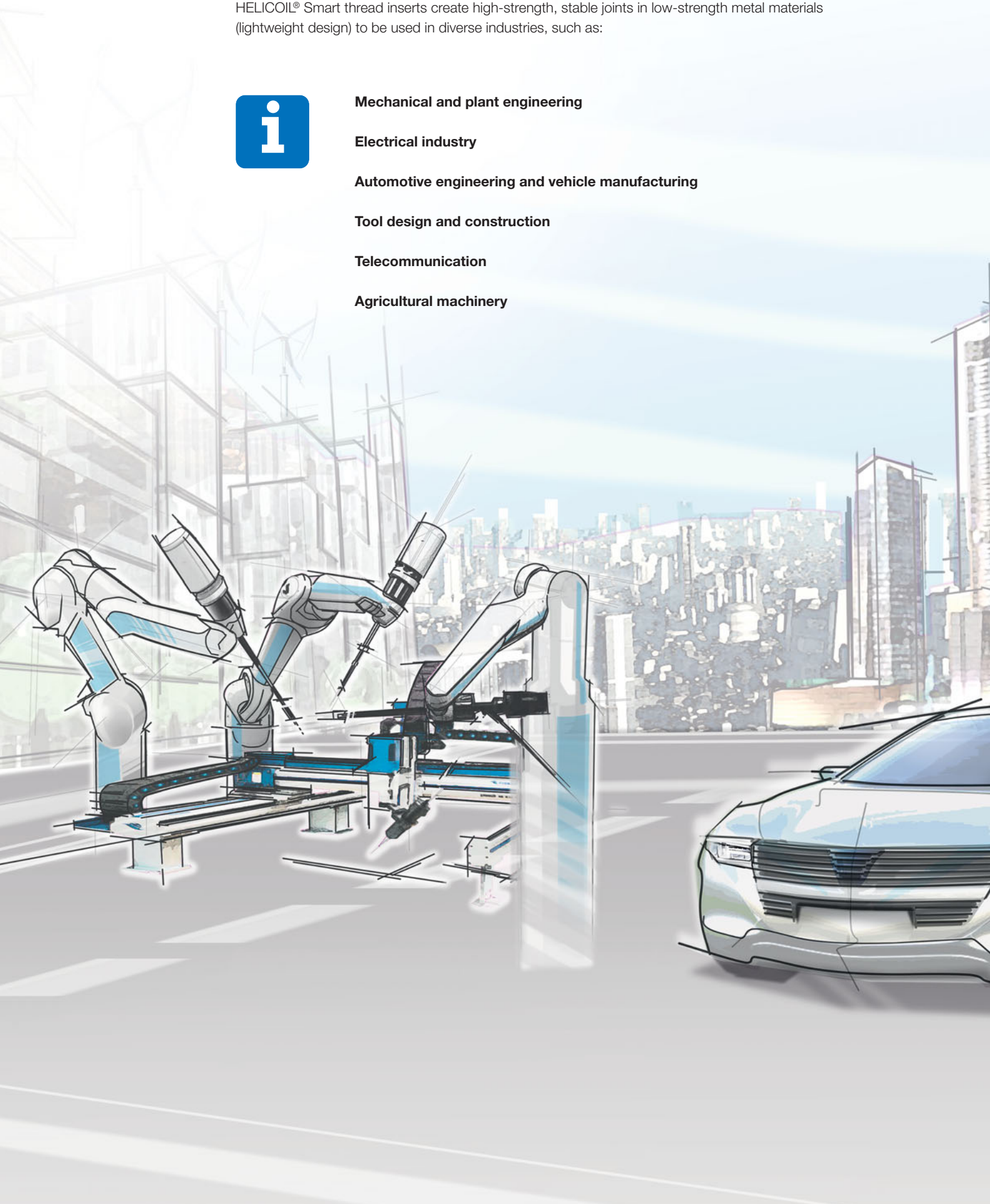

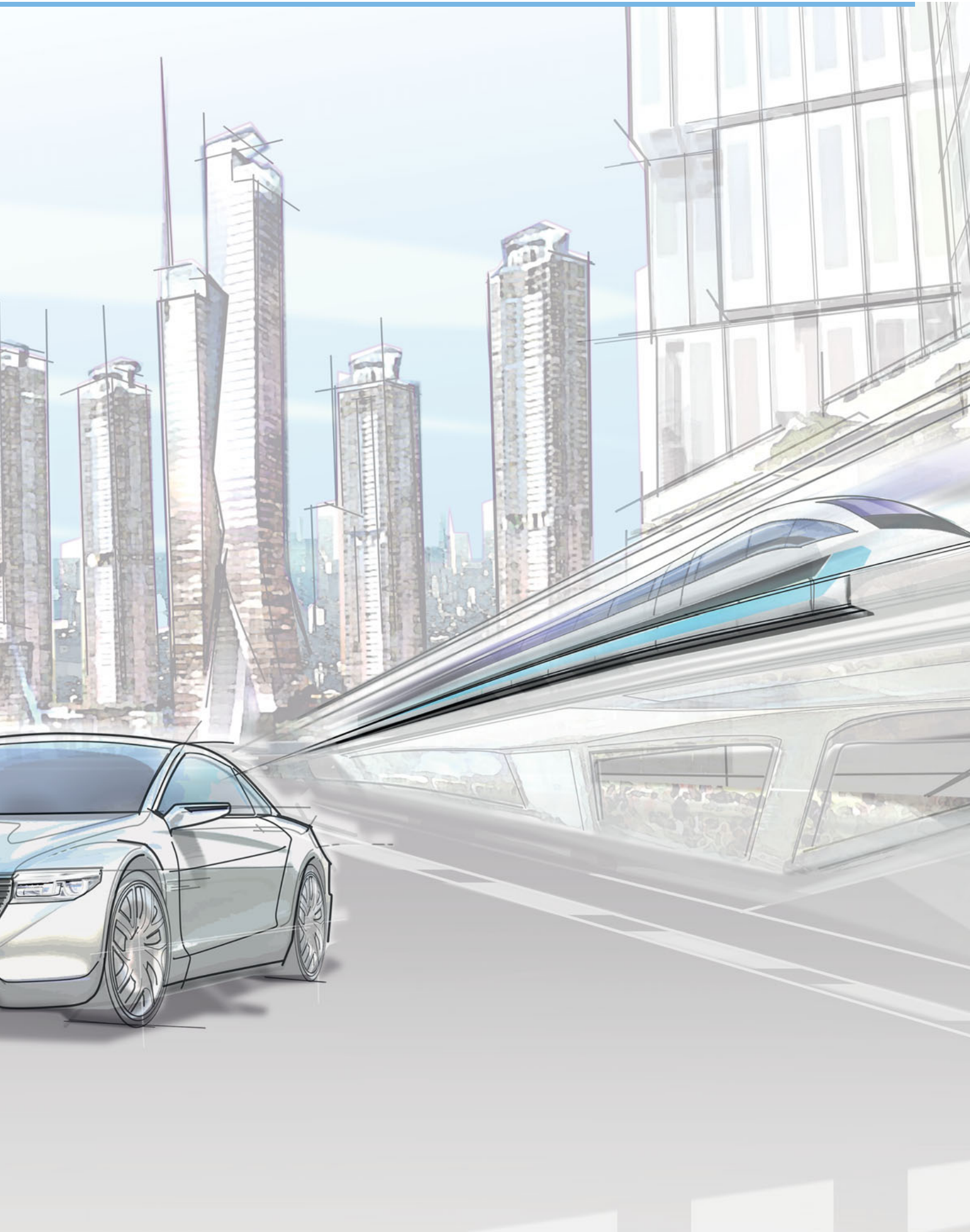

HELICOIL® Smart Free Running



The new thread insert merges the advantages of the HELICOIL® Plus and the HELICOIL® Tangfree. Every thread of the thread insert with precision-formed, rhombic profile is free running. The result is a true-to-gauge internal thread including the last thread which is in every case threadable.

Just like the HELICOIL® Plus, the HELICOIL® Smart is provided with a special thread start to allow easier installation in a holding thread. There is a tang, but it does not have to be broken off and removed. The installation time is therefore reduced by approx. 20 %. The installation of the HELICOIL® Smart is fully automatable. In combination with the adapted installation tools, the new generation of the HELICOIL® technology is a perfect addition to the HELICOIL® product family.

HELICOIL® Tangfree Free Running*



You do not need a tang to install these thread inserts. Therefore, tang break and removal are not required. Combined with the matching installation tools, this innovation status in the HELICOIL® technology is a perfect addition to the HELICOIL® product family.

Simply order the separate catalogue no. 0150.

HELICOIL® Tangfree Screwlock*



HELICOIL® Tangfree Screwlock has the same advantages as HELICOIL® Tangfree. In addition, there is a screw-locking area. The screw is locked by one or several polygonal-shaped threads clamping the flanks of the screwed in screw. The elastically resilient frictional locking results in prevailing torques similar to the specifications of ISO 2320. These screw locking torques meet the demands of technical delivery terms regarding international standard specifications.

HELICOIL® Tangfree Screwlock can only be used with screws of higher property classes (8.8 and higher). Common lubricants according to the manufacturers' recommendations shall be used for highly alloyed screws. This thread insert is widely used in the aviation industry.

Simply order the separate catalogue no. 0150.

HELICOIL® Plus Free Running



Every thread of the thread insert with precision-formed, rhombic profile is free running. The result is an internal thread true to gauge that can be used from both ends. The dimensional stability of the ISO thread complies with DIN 13 6H as well as for special requirements with 4H and meets the demands on international standard specifications.

The advantages of the HELICOIL® Plus system are particularly apparent with respect to processing and tools and result in shorter cycle times.

Simply order the separate catalogue no. 0100.

* Comply with standards NAS 1130 and NAS 0276.

HELICOIL® Plus Screwlock



This thread insert has an additional screw-loss protection area. One or several polygonal-shaped threads clamp the flanks of the installed screw. The elastically resilient frictional locking results in prevailing torques similar to the specifications of ISO 2320. These screw locking torques meet the demands of technical delivery terms regarding international standard specifications. However, the prevailing torques can also be adjusted as required for the corresponding application, e.g. for securing of setting screws. HELICOIL® Plus Screwlock can only be used with screws of higher property classes (8.8 and higher). Common lubricants according to the manufacturers' recommendations should be used for highly alloyed screws. The advantages of the HELICOIL® Plus system are particularly apparent with respect to processing and tools and result in shorter cycle times. Simply order the separate catalogue no. 0100.

HELICOIL® Classic Free Running



Every thread of the thread insert with precision-formed, rhombic profile is free running. The result is an internal thread true to gauge that can be used from both ends. The dimensional stability of the ISO thread complies with DIN 13 6H as well as for special requirements with 4H and meets the demands on international standard specifications.

HELICOIL® Classic Screwlock



This thread insert has an additional screw-loss protection area. One or several polygonal-shaped threads clamp the flanks of the installed screw. The elastically resilient frictional locking results in prevailing torques similar to the specifications of ISO 2320. These screw locking torques meet the demands of technical delivery terms regarding international standard specifications. However, the prevailing torques can also be adjusted as required for the corresponding application, e.g. for securing of setting screws. HELICOIL® Classic Screwlock can only be used with screws of higher property classes (8.8 and higher). Common lubricants according to the manufacturers' recommendations should be used for highly alloyed screws.

Efficient combination

HELICOIL® locknuts



HELICOIL® locknuts consist of a nut body and an integrated HELICOIL® Plus Screwlock thread insert. One or several polygonal-shaped threads clamp the flanks of the screwed in screw resulting in elastically resilient frictional locking. The achieved prevailing torques are similar to the specifications of ISO and meet the demands of technical delivery terms regarding international standard specifications. Moreover, they can also be adjusted as required for the corresponding application. HELICOIL® nuts are available in different materials. Simply order the separate catalogue no. 0560.

HELICOIL® Smart thread inserts can be easily and economically installed because there are only a few basic rules to observe. There is a broad range of installation tools for efficient installation – for individual applications as well as for large-scale production. Installation phases are as follows:



Drilling

Common twist drills are used.

Notes on diameter and tapped hole depth are given on page 19.

Prior to tapping, counter-bore 90° and deburr. Outside diameter of **countersink = $D_{HC} + 0.1$ mm.**

On the cut holding thread, the countersink is hardly visible.

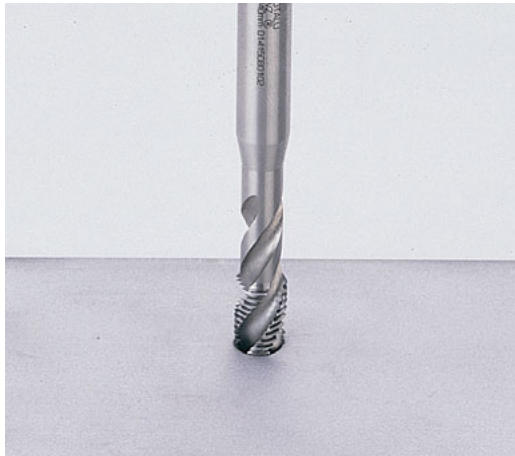

Tapping

To tap the HELICOIL® Smart holding thread, system-dependent original HELICOIL® taps must be used.

Recommendations for suitable manual and machine taps are given in our catalogue no. 0100. The trueness to gauge of the holding thread must be checked with HELICOIL® thread plug limit gauges.



Form tapping

Today, chipless production of internal threads with forming taps is an efficient production method for many materials. This also applies to the HELICOIL® Smart.

The installation can be done with hand-operated, machine tools.



Spin-on the HELICOIL® Smart



Upon screwing-in, the blade has a pull-in function



Locating the HELICOIL® Smart at the start of the thread and screw-in

By turning the threaded mandrel or triggering the drive, the thread insert is screwed in.

The HELICOIL® Smart must be installed at least 0.25 P below the surface of the component in order to guarantee a correct installation (see page 19).

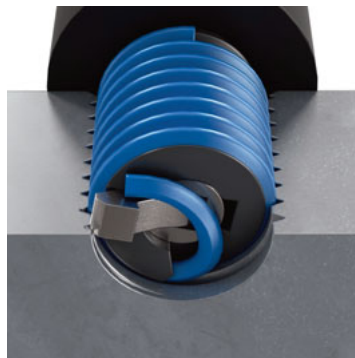

Extension of the blade, which bends the tang back and compresses it.



Engaging of the blade and unscrew the mandrel



Correct installation of HELICOIL® Smart (0.25 – 0.5 x P below the surface of component)



Free CAD download

We offer a free CAD download service. Download 3-D models of Böllhoff products and directly integrate them into your designs.

www.boellhoff.de/en/cad



HELICOIL® Smart

The new generation of thread technology for high-strength joints

<https://youtu.be/2hGnZu4SUxM>

Determination of nominal length

Guide values to determine the minimum length of the HELICOIL® Smart thread insert depending on parent material and screw property class, valid for 20°C.

Strength of parent material	Screw property class									
	3.6 4.6	4.8 5.6	5.8 6.6	6.8 6.9	8.8	9.8	10.9	12.9	14.9	
to 100	1.5 d	1.5 d	2 d	2.5 d	3 d	3 d	–	–	–	
> 100 – 150	1.5 d	1.5 d	2 d	2 d	2.5 d	2.5 d	2.5 d	2.5 d	3 d	
> 150 – 200	1 d	1.5 d	1.5 d	1.5 d	2 d	2 d	2 d	2.5 d	2.5 d	
> 200 – 250	1 d	1 d	1.5 d	1.5 d	1.5 d	1.5 d	2 d	2.5 d	2.5 d	
> 250 – 300	1 d	1 d	1 d	1 d	1.5 d	1.5 d	1.5 d	2 d	2 d	
> 300 – 350	1 d	1 d	1 d	1 d	1 d	1.5 d	1.5 d	1.5 d	2 d	
> 350 – 400	1 d	1 d	1 d	1 d	1 d	1 d	1.5 d	1.5 d	1.5 d	
> 400	1 d	1 d	1 d	1 d	1 d	1 d	1.5 d	1.5 d	1.5 d	

The table of values to determine the nominal length applies to aluminium as well as to materials with a ratio from $\frac{\text{shear stress}}{\text{tensile stress}} = 0.6$ to 0.7 .
Some iron cast alloys have a ratio ranging from $\frac{\text{shear stress}}{\text{tensile stress}} = 0.8$ to 1.4 . (source: VDI 2230)

For these guide values, the screw is the weaker joint member.
Lengths can be shorter than the recommended nominal lengths if tests confirm this.
Intermediate lengths are also available.

Temperature limits for validity: aluminium alloys $T_{\text{max}} = 300$ °C, magnesium alloys $T_{\text{max}} = 100$ °C.

For the design of screw joints under thermal stress, the changes of temperature-dependent material parameters must be taken into account.

* 1 N/mm² equals 1 MPa

Minimum wall thickness

(related to outside diameter of the HELICOIL® receiving thread)

The minimum wall thickness mainly depends on individual operating data.

These define material strength and length of thread engagement. The indicated guide value formulas apply to aluminium, cast and wrought alloys and a length of thread engagement of the HELICOIL® Smart of 1.5 d.

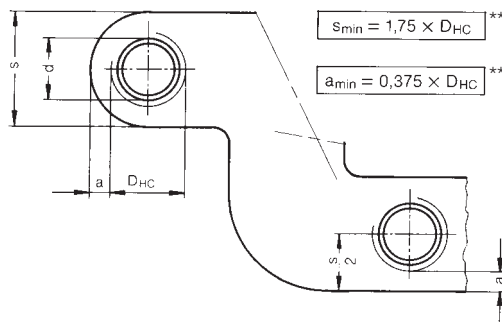

d = nominal Ø
D_{HC} = outside Ø of the receiving thread
a = residual wall thickness

** For grey cast iron on request.

Representation with the example of M 10 x 15:

HELICOIL® Plus



Blind hole for HELICOIL® with tang according to DIN 76 Part 1 (normal case)

HELICOIL® Smart



- Extremely short tapping possible.
- Minimal remaining wall thickness at the bottom of the bore feasible
- Pushing with a tang break-off tool is avoided Benefits: Minimal wall thickness and weight reduction
- Design of very short thread domes possible

HELICOIL® Smart technical data and item numbers

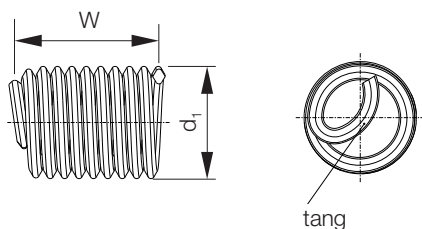

The control values of not installed thread insert free running are W and d₁.
The length can only be measured for installed thread inserts.

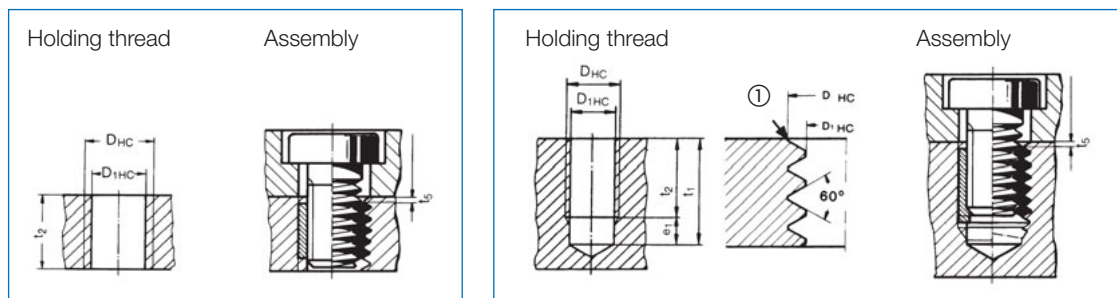

① **If countersunk or burred: maximum outside diameter = D_{HC} 0/+ 0.1 mm.**
The countersink is hardly visible on the HELICOIL® holding thread.

All dimensions in mm. Subject to technical change without notice.

- d = Nominal thread diameter
- P = Thread pitch
- d₁ = Outside diameter of thread insert prior to installation
- W = Number of threads prior to installation
- D_{HC} = Outside diameter of holding thread
- D_{1HC} = Crest diameter
- B = Suitable twist drill diameter
- e₁ = Core hole depth for standard threads

P	0.50	0.60	0.70	0.75	0.80	1.00	1.25	1.50	1.75	2.00
e₁	2.0	2.4	2.8	3.0	3.2	4.0	5.0	6.0	7.0	8.0

- t₁ = Minimum depth of tap hole
- t₂ = The nominal length of the thread insert corresponds to the minimum length of the full holding thread for blind holes or to the minimum plate thickness for a through hole.
- t₅ = Distance of the thread insert to the joint face = min. 0.25 to 0.5 P, if t₂ corresponds to the abovementioned minimum value

The HELICOIL® Smart enables very short holding threads, since no axial space for the tang break-off is required.

Dimensions	d	P	t ₂ min		W	d ₁ min. max.	D _{1HC} min. max.	B	D _{HC} min.	HELICOIL® Smart Free Running
			x d	mm						
M 4	0.70	0.70	1.5	6.00	5.7	5.05	4.15	4.2	4.91	6130 004 006
			2	8.00	8.0	5.25	4.29			6130 004 008
M 5	0.80	0.80	1.5	7.50	6.5	6.35	5.17	5.2	6.04	6130 005 0075
			2	10.00	9.3	6.60	5.33			6130 005 0010
M 6	1.00	1.00	1.5	9.00	6.5	7.60	6.22	6.3	7.30	6130 006 0009
			2	12.00	9.2	7.85	6.41			6130 006 0012
M 8	1.25	1.25	1.5	12.00	7.0	9.85	8.27	8.4	9.62	6130 008 0012
			2	16.00	10.2	10.10	8.48			6130 008 0016
M 10	1.50	1.50	1.5	15.00	7.7	12.10	10.32	10.5	11.95	6130 010 0015
			2	20.00	10.8	12.50	10.56			6130 010 0020
M 12	1.75	1.75	1.5	18.00	8.0	14.40	12.38	12.5	14.27	6130 012 0018
			2	24.00	11.3	14.80	12.64			6130 012 0024



System modules – the fastener

	Page
Technology	9
A close look at the advantages	10
Fields of application	12
Designs	14
Installation	16
Design guidelines	18
Technical data and item numbers	19

System modules – the tool

Pneumatic installation tool	22
Spare parts	24
Wear parts	25
Accessories	26
Extraction tool	27
Automation	27



The system in the focus

Your benefit: You obtain a complete system solution consisting of coil thread inserts and specially developed installation tools. This assures the quality of the joints.

Depending on the motor version, you can use the pneumatic installation tool of type P-S to quickly process HELICOIL® Smart thread inserts ranging between M4 and M12. For more detailed information, please see the following page.

Benefit from

- Robust installation without loss of performance
- Easy handling and operation
- A high-quality drive



When ordering a complete pneumatic installation tool including an installation mandrel with depth stop, the torque for the respective dimension is pre-adjusted on the installation tool.



Pneumatic installation tool plus installation mandrel with depth-stop	P-S 408S	P-S 10S	P-S 12S
M 4	6160 270 4000		
M 5	6160 270 5000		
M 6	6160 270 6000		
M 8	6160 270 8000		
M 10		6160 281 0000*	
M 12			6160 291 2000*

* Please use it only with spare handle for P-S 10S and P-S 12S, see accessories page 26.

Pneumatic installation tools for **HELICOIL® Smart**

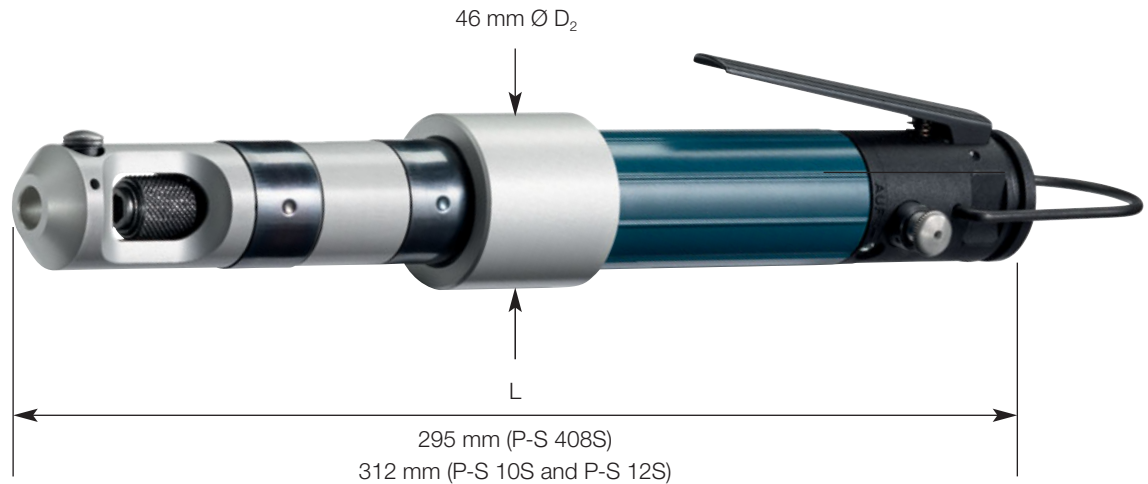

Typ P-S 408S

For quick processing of HELICOIL® Smart thread inserts M 4 to M 8 with corresponding installation mandrel (order separately)

Technical data:

Idle speed:	1500 rpm at p = 6.3 bar, adjustable through air pressure
Air consumption:	5.5 l/s at p = 6.3 bar
Torque:	M = 4.5 Nm
Tool holder:	1/4" hexagon socket with radial bearing
Weight:	0.8 kg
Item No:	6160 270 0010

HELICOIL® Smart installation mandrels depending on the size with depth stop must be ordered separately, see page 24.

Typ P-S 10S

For quick processing of HELICOIL® Smart thread inserts M 10 with corresponding installation mandrel (order separately)

Technical data:

Idle speed:	600 rpm at p = 6.3 bar, adjustable through air pressurer
Air consumption:	5.5 l/s at p = 6.3 bar
Torque:	M = 7 Nm
Tool holder:	1/4" hexagon socket with radial bearing
Weight:	1.1 kg
Item No:	6160 280 0000

HELICOIL® Smart installation mandrels depending on the size with depth stop must be ordered separately, see page 24. Please use it only with spare handle for P-S 10S and P-S 12S, see accessories page 26.

Typ P-S 12S

For quick processing of HELICOIL® Smart thread inserts M 12 with corresponding installation mandrel (order separately)

Technical data:

Idle speed:	380 rpm at p = 6.3 bar, adjustable through air pressure
Air consumption:	5.5 l/s at p = 6.3 bar
Torque:	M = 10 Nm
Tool holder:	1/4" hexagon socket with radial bearing
Weight:	1.1 kg
Item No:	6160 290 0000

HELICOIL® Smart installation mandrels depending on the size with depth stop must be ordered separately, see page 24. Please use it only with spare handle for P-S 10S and P-S 12S, see accessories page 26.

Installation mandrel Free Running

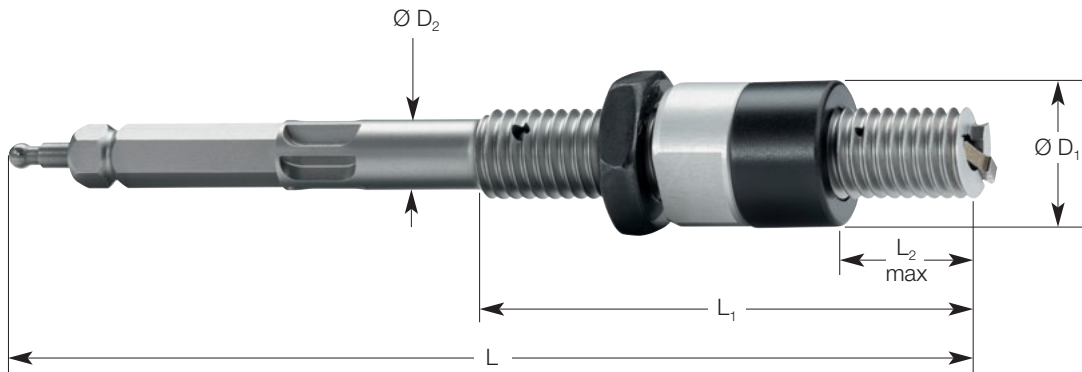

Type	Nominal thread diameter d	L_1	L_2 max.	L	D_1	D_2 $\varnothing 8-0,2$	Installation mandrel Order number
P-S 408S	M4	34	20	110	8	8	6160 230 4020
	M5	40	22	115	9,5		6160 230 5020
	M6	40	22	115	11		6160 230 6020
	M8	50	28	111	14,5		6160 250 8020
P-S 10S	M10	56	31,5	115	16	8	6160 251 0020
P-S 12S	M12	62	37	124	20	8	6160 251 2020

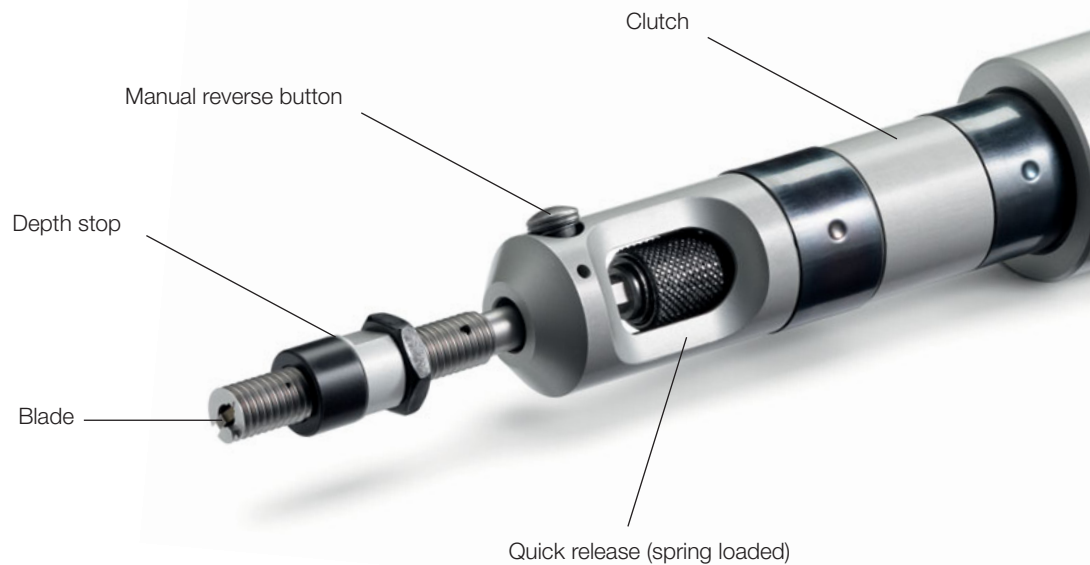

HELICOIL® Smart wear parts

Installation blade



Type	Nominal thread diameter d	Installation blade Order number
P-S 408S	M4	6160 230 4023
	M5	6160 230 5023
	M6	6160 230 6023
	M8	6160 250 8023
P-S 10S	M10	6160 251 0023
P-S 12S	M12	6160 251 2023



Pneumatic engine



HELICOIL® Smart
 Pneumatic installation tool P-S 408S
<https://youtu.be/vJ7J41ce2t0>

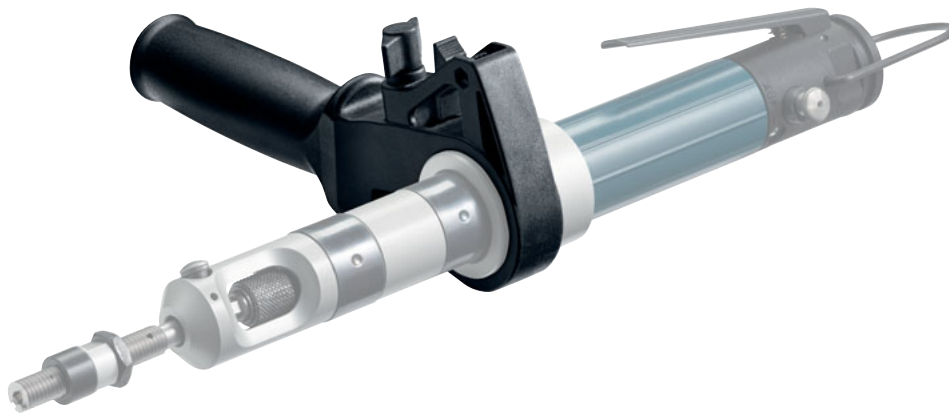

Spare handle for Type P-S 10S and Type P-S 12S

Handle for safe compensation of installation torque for HELICOIL® Smart ≥ M 10
 Type P-S 10S and Type P-S 12S
 Item No: 4160 180 0006



**Parallel system type S for
 HELICOIL® Smart and
 HELICOIL® Plus installation tools**

Type	Product characteristics		Item No
S 600	Work radius	130 mm–450 mm	0182 080 0003 (see delivery scope)
	Work height	50 mm–450 mm	
	Weight without tool	8 kg	
	Torque absorption	15 Nm max.	

Advantages:

- Rationalisation
- Quick and safe positioning especially for small dimensions ≤ M 5 or 8-32 UNC
- Easy handling, no operator fatigue (no return rotation forces)
- Absorption of screwdriver weight
- Can be used with electrical and pneumatic HELICOIL® installation tools

Delivery scope:

- 3-axis guiding system
 - Tool holder
 - 1 counterbalance 1–3 kg
 - Base plate made of extruded aluminium profile with grooves, dimensions w x h x l: 240 x 40 x 500 mm
- Screwdriver and control unit not included in delivery.

HELICOIL® extraction tool



HELICOIL® extraction tool
M 3 to M 5



HELICOIL® extraction tool
M 6 to M 56

For manual and machine disassembly of HELICOIL® Smart thread inserts M4 to M12.

Delivery scope:

- Extracted tool
- Adapter for 1/4" hexagon
- Operating instructions
- Telescoping sleeve

Deep-installed HELICOIL® thread inserts can be extracted without damaging the parent thread:

	Steel	Aluminium $R_m > 200 \text{ N/mm}^2$ *	Aluminium $R_m < 200 \text{ N/mm}^2$ *
Flush-mounted HELICOIL®	OK	OK	OK
Deep-mounted HELICOIL®	OK	OK	limited

Nominal thread Ø	Item No
M 4	0180 604 0000
M 5	0180 605 0000
M 6	0180 606 0000
M 8	0180 608 0000
M 10	0180 610 0000
M 12	0180 612 0000

The tool can be assembled using a tap wrench, ratchet or cordless screwdriver.
The tool comes with an adapter for a cordless screwdriver.

* 1 N/mm² equals 1 MPa

HELICOIL® automation

The economical installation of HELICOIL® thread inserts is just as important as the high quality standard.

That is why we offer modules for integration into automatic processes as well as complete systems.

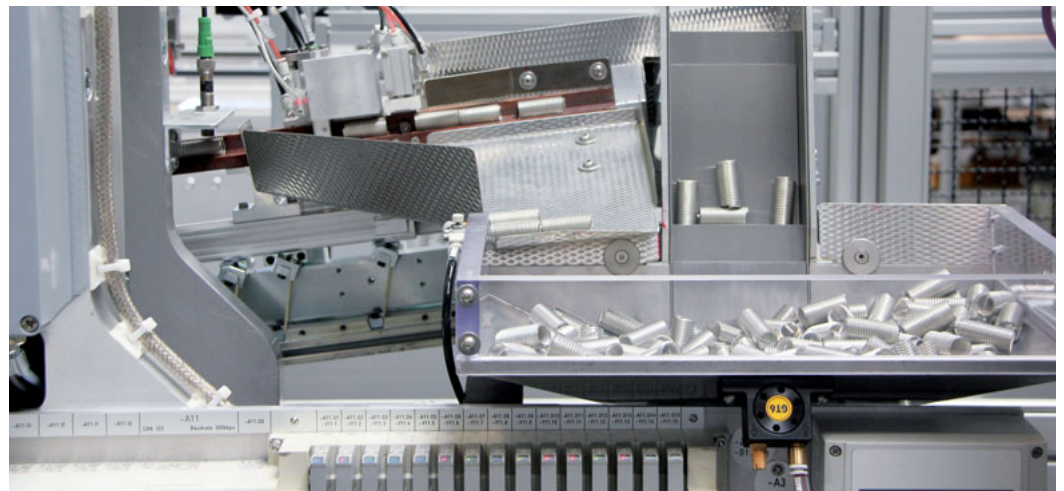

BÖLLHOFF

Worldwide for you a strong partner – at 39 locations in 24 countries.

Böllhoff Group

Please find your local contact on www.boellhoff.com
or contact us under fasteningtechnology@boellhoff.com



KEL Bulgaria Ltd.

Please find your local contact on www.kelbulgaria.com
or contact us under info@kelbulgaria.com
Telephone: +359 877008832

