











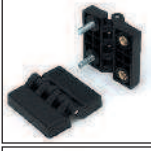

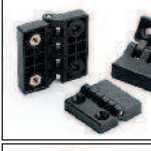
Hinges

Page		Page	
89		93	
89		93	
89		93	
89			
90			
90			
90			
90			
91			
91			
92			
92			

4754K FLAT HINGE K WITH THREADED INSERTS

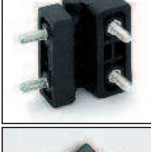
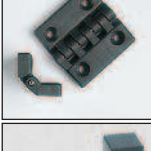
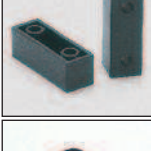

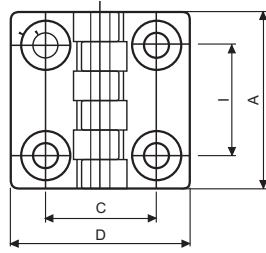
Code	A	D	I	C	H	B	d	e1	Color
475404301	48	48	30	30	15.5	10.5	M5	7	Black
475406301	64	64	40	40	19	13	M6	9	Black
475409301	95	95	60	63	28.5	19	M8	13	Black

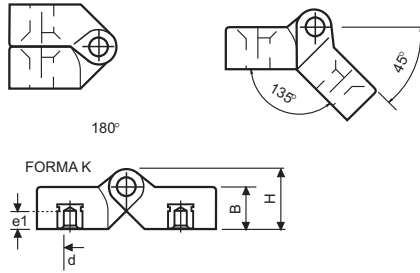

Brass inserts.
PA: Polyamide.
Zinc plated steel pin .

4754M FLAT HINGE M WITH THREADED INSERTS AND THREADED STUDS

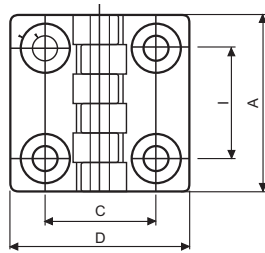
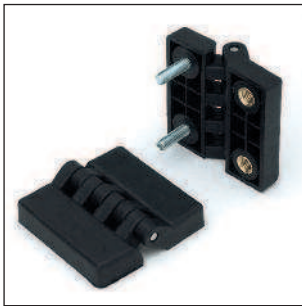

Code	A	D	I	C	H	B	d	e	e1	Color
475404701	48	48	30	30	15.5	10.5	M5	15	7	Black
475406701	64	64	40	40	19	13	M6	20	9	Black
475409701	95	95	60	63	28.5	19	M8	20	13	Black

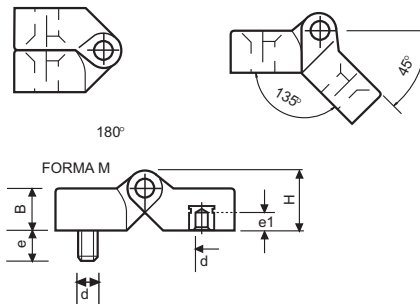

Treated steel studs and brass inserts.
PA: Polyamide.
Zinc plated steel pin.

4754N FLAT HINGE N WITH THROUGH HOLES AND THREADED INSERTS

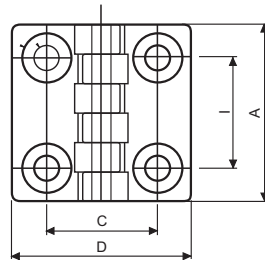

Code	A	D	I	C	H	B	d	d1	e1	Color
475404402	48	48	30	30	15.5	10.5	M6	6.5	7	Black
475406401	64	64	40	40	19	13	M6	6.5	9	Black

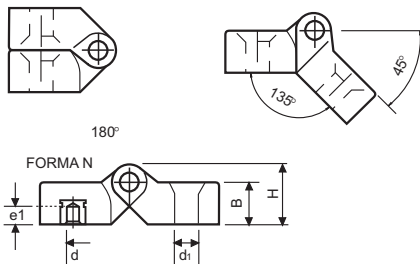

Brass inserts and through holes.
PA: Polyamide.
Zinc plated steel pin .

4754T FLAT HINGE T WITH THREADED STUDS

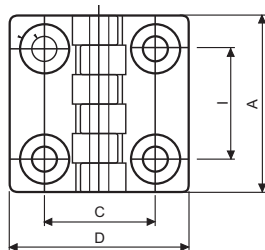

Code	A	D	I	C	H	B	d	e	Color
475404501	48	48	30	30	15.5	10.5	M5	15	Black
475406501	64	64	40	40	19	13	M6	20	Black
475409501	95	95	60	63	28.5	19	M8	20	Black

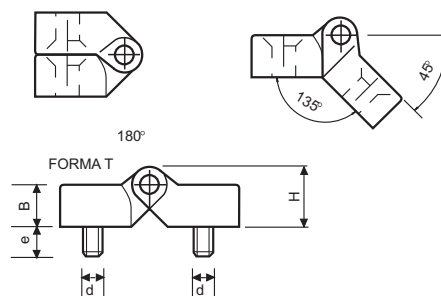

Treated steel studs.
PA: Polyamide.
Zinc plated steel pin .

4755K HK HINGE WITH THREADED INSERTS

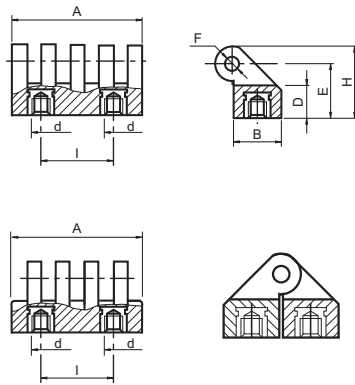

Code	A	D	I	d	E	B	H	F	Color
475503551	30	11	15	M5	19	17	25	4	Black
475505351	54	13	30	M6	22	20	29	5	Black
475507351	78	16	42	M8	31	30	42	8	Black

Brass inserts.
PA: Polyamide.
Zinc plated steel pin. Complete rotation: 180°.

4755K* HK* HINGE WITH THREADED INSERTS

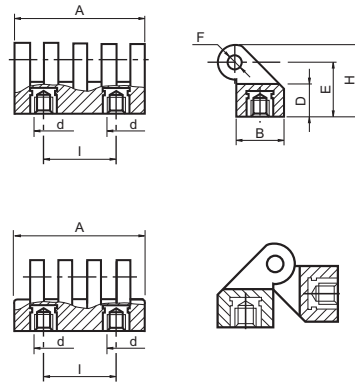

Code	A	D	I	d	E	B	H	F	Color
475503553	30	11	15	M5	19	17	25	4	Black
475505353	54	13	30	M6	22	20	29	5	Black
475507353	78	16	42	M8	31	30	42	8	Black

Brass inserts.
PA: Polyamide.
Zinc plated steel pin. Complete rotation: 180°.

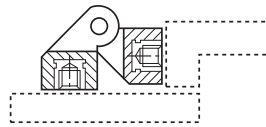

MOUNTING EXAMPLE

4755T HT HINGE WITH THREADED STUDS

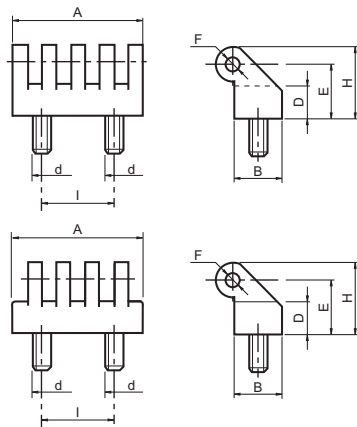

Code	A	D	I	d	E	B	H	F	Color
475503552	30	11	15	M5	19	17	25	4	Black
475505352	54	13	30	M6	22	20	29	5	Black
475507352	78	16	42	M8	31	30	42	8	Black

Treated steel studs.
PA: Polyamide.
Zinc plated steel pin. Complete rotation: 180°.

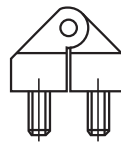

4755T* HT* HINGE WITH THREADED STUDS

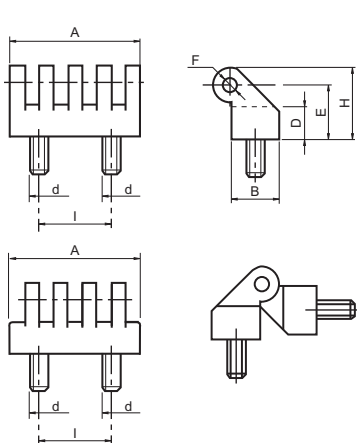

Code	A	D	I	d	E	B	H	F	Color
475503554	30	11	15	M5	19	17	25	4	Black
475505354	54	13	30	M6	22	20	29	5	Black
475507354	78	16	42	M8	31	30	42	8	Black

Treated steel studs.
PA: Polyamide.
Zinc plated steel pin. Complete rotation: 180°.

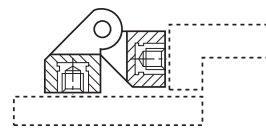

MOUNTING EXAMPLE

4756 THROUGH HOLE HINGE

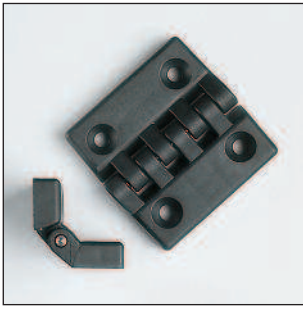

PA: Polyamide.
Zinc plated steel pin.

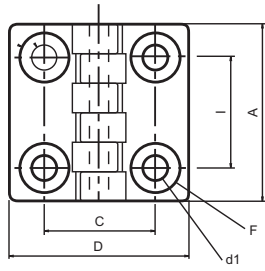

Code	A	D	I	C	d1	B	H	F	Color
475603050	32	32	20	20	4.5	7	10.5	8	Black
475604055	48	48	30	30	6.5	10.5	15.5	13	Black
475606056	64	64	40	40	6.5	13	19	13	Black
475609050	96	96	60	63	8.5	16	24	16	Black
475610050	96	96	60	63	10.5	16	24	20	Black

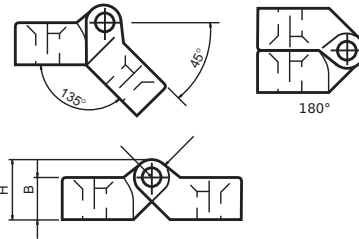

4756 THROUGH HOLE HINGE WITH STAINLESS STEEL PIN

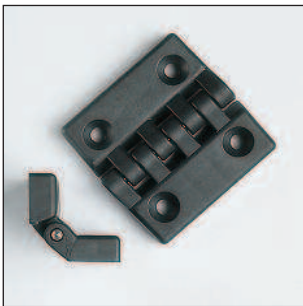

PA: Polyamide.
Stainless steel pin.

INOX
Stainless
Steel

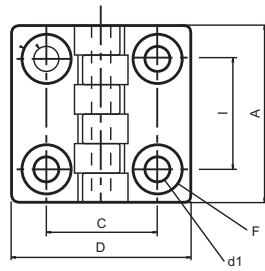

Code	A	D	I	C	d1	B	H	F	Color
475603150	32	32	20	20	4.5	7	10.5	8	Black
475604150	48	48	30	30	6.5	10.5	15.5	13	Black
475606150	64	64	40	40	6.5	13	19	13	Black
475609150	96	96	60	63	8.5	16	24	16	Black
475610150	96	96	60	63	10.5	16	24	20	Black

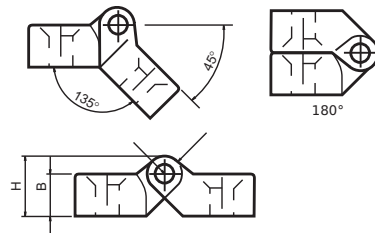

4757 SHIM FOR HINGE WITH THROUGH HOLES 4756

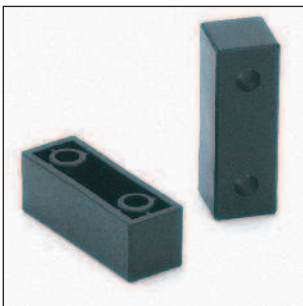

PA: Polyamide.

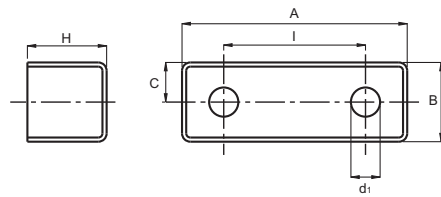

Code	A	I	C	d1	B	H	Color
475741030	48	30	8	8.5	22	22.5	Black
475741140	65	40	11	8.5	22	22.5	Black

4246 233 THROUGH HOLE HINGE



PA: Reinforced polyamide.
Pin made of stainless-steel.
Maximum rotation 270°.

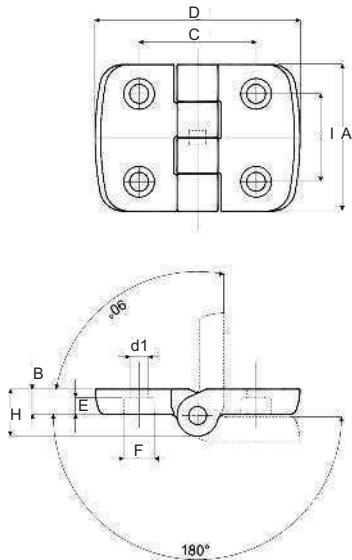

Code	A	D	I	C	d1	F	B	E	H	Color
424680970	50	50	34	34	5,5	10,5	8,5	3,5	16	Black
424680772	50	50	30	31	5,5	9	8,5	5	16	Black
424680773	50	70	30	40	6,5	10,5	8,5	6	16	Black
424680774	50	70	30	46	6,5	10,5	8,5	6	16	Black
424680775	50	70	30	46	8,5	13,5	8,5	5	16	Black

4247 234 THROUGH HOLE HINGE



PA: Reinforced polyamide.
Pin made of stainless-steel.
Maximum rotation 270°.

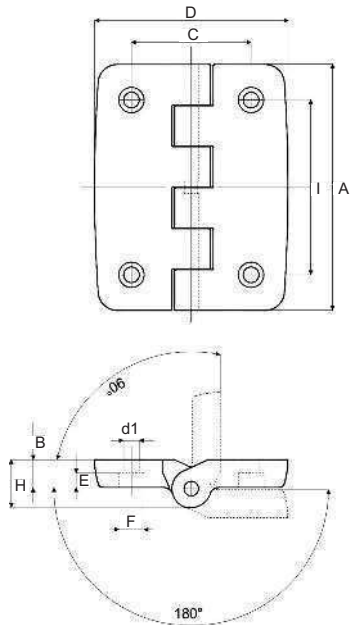

Code	A	D	I	C	d1	F	B	E	H	Color
424780776	102	80	72,5	49,5	6,5	10,5	11,5	6	20	Black
424780777	102	80	72,5	49,5	8,5	13,5	11,5	8	20	Black

4756 BK METALIC THROUGH HOLE HINGE, BLACK

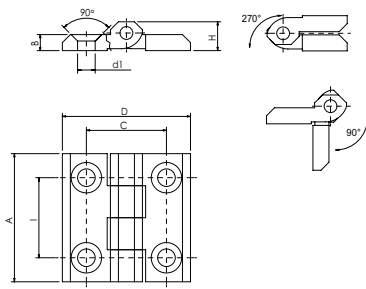

Code	A	D	I	C	d1	B	H	Color
475604910	40	40	25	25	5,5	5	9	Black
475605910	50	50	30	30	6,5	6	11,5	Black
475606910	60	60	36	36	6,5	6	11,5	Black
475607910	64	64	40	40	6,5	6	11,5	Black

Za: zinc die-cast, black.
Stainless steel pin AISI 303.

4756 CR METALIC THROUGH HOLE HINGE, CHROMED

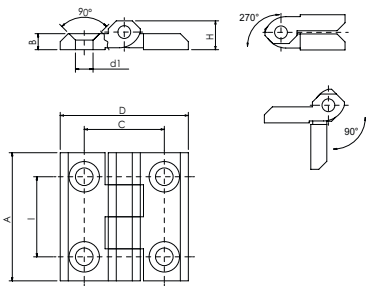

Code	A	D	I	C	d1	B	H	Color
475604920	40	40	25	25	5,5	5	9	Chrome
475605920	50	50	30	30	6,5	6	11,5	Chrome
475606920	60	60	36	36	6,5	6	11,5	Chrome

Za: zinc die-cast, chromed.
Stainless steel pin AISI 303.

4756 INOX STAINLESS STEEL THROUGH HOLE HINGE

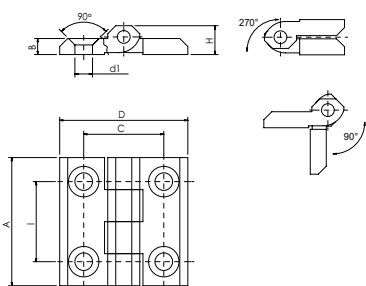

Code	A	D	I	C	d1	B	H	Color
475604930	40	40	25	25	5,5	5	9	Natural
475605930	50	50	30	30	6,5	6	11,5	Natural
475606930	60	60	36	36	6,5	6	11,5	Natural

SS: Stainless Steel AISI 316.
Stainless steel pin AISI 303.