

# Knobs

Page		Page		Page		Page		Page	
1		5		10		15		23	
1		5		11		15		23	
2		6		11		15		23	
2		7		11		16		24	
2		7		12		17		24	
3		8		12		18		24	
3		8		12		18		25	
3		9		12		18		25	
3		9		13		20		26	
4		9		13		21		26	
4		10		13		22		26	
4		10		14		22		27	
								27	
								27	
								28	
								28	
								28	
								29	
								29	
								29	
								30	
								30	
								30	
								31	

# Knobs

Page		Page		Page	
31		35		38	
32		35			
32		36			
32		36			
33		36			
33		36			
34		37			
34		37			
34		37			
34		37			
35		38			
35		38			

## 1102C DIN 319 C WITH THREADED HOLE

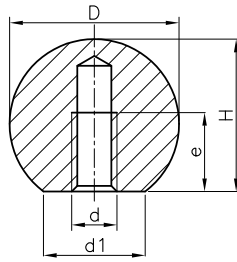

Molded thread.  
PF: Black or Red Duroplast FS 31 DIN 7708.



RAL 3002

Code	D	d	d1	e	H	Color
110212101	12	M4	5	7	11	Black
110216101	16	M4	8	9	15	Black
110220101	20	M5	12	13	18	Black
110225101	25	M6	15	16	23	Black
110230101	30	M8	15	19	27	Black
110235101	35	M10	18	24	32	Black
110240101	40	M10	22	26	37	Black
110245101	45	M12	22	31	43	Black
110250101	50	M12	27	34	47	Black
110216102	16	M4	8	9	15	Red
110220102	20	M5	12	13	18	Red
110225102	25	M6	15	16	23	Red
110230102	30	M8	15	19	27	Red
110235102	35	M10	18	24	32	Red
110240102	40	M10	22	26	37	Red
110245102	45	M12	22	31	43	Red
110250102	50	M12	27	34	47	Red

## 1102K DIN 319 K WITH THREADED INSERT

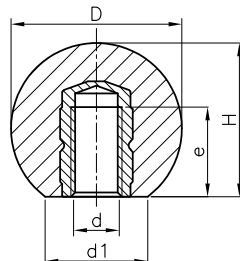

Threaded female brass insert.  
PF: Black Duroplast FS 31 DIN 7708..

Code	D	d	d1	e	H	Color
110216301	16	M4	8	6	15	Black
110220301	20	M5	12	8	18	Black
110225301	25	M6	15	10	23	Black
110230301	30	M8	15	14	27	Black
110235301	35	M10	18	16	32	Black
110240301	40	M10	22	16	37	Black
110245301	45	M12	22	18	43	Black
110250301	50	M12	27	18	47	Black

## 4706 TMP BALL KNOB C WITH THREADED HOLE

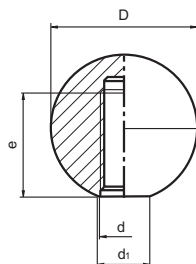

Molded thread.  
PA: Polyamide.  
Other thread, plain hole or brass or SS insert on demand (min. 500 units).  
For different colours, please ask.

Code	D	d	d1	e	Color
470615101	15	M4	8	8	Black
470620101	20	M5	10	12	Black
470625101	25	M6	14	16	Black
470630101	30	M8	14	20	Black
470635101	35	M10	16	23	Black
470640101	40	M10	16	28	Black
470645101	45	M12	18	30	Black
470650101	50	M12	18	36	Black

## 1111C KNURLED BALL C WITH THREADED HOLE

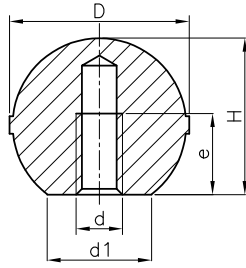

Code	D	d	d1	e	H	Color
111120101	20	M5	12	8	18	Black
111125101	25	M6	15	10	23	Black
111130101	30	M8	16	14	27	Black
111135101	35	M10	19	16	32	Black
111140101	40	M10	22	16	37	Black
111145101	45	M12	20	18	43	Black
111150101	50	M12	20	18	47	Black
111155101	55	M12	20	18	53	Black

Molded thread.  
PF: Black Duroplast FS 31 DIN 7708.

## 1111K KNURLED BALL K WITH THREADED INSERT

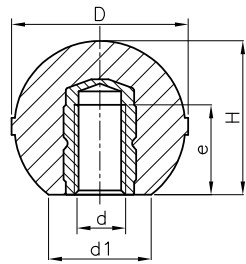

Code	D	d	d1	e	H	Color
111120301	20	M5	12	9	18	Black
111125301	25	M6	15	10	23	Black
111130301	30	M8	16	14	27	Black
111135301	35	M10	19	17	32	Black
111140301	40	M10	22	17	37	Black
111145301	45	M12	20	19	43	Black
111150301	50	M12	20	19	47	Black
111155301	55	M12	20	19	53	Black

Threaded female brass insert.  
PF: Black Duroplast FS 31 DIN 7708.

## 1105 ITAL C WITH THREADED HOLE

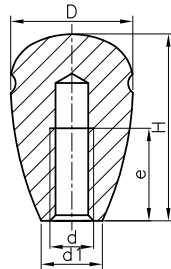

Code	D	d	d1	e	H	Color
110519101	19	M5	10	15	30	Black
110522101	22	M6	13	19	34	Black
110529101	29	M8	15	23	44	Black
110535101	35	M10	16	25	51	Black
110537101	37	M10	17	25	58	Black

Molded thread.  
PF: Black Duroplast FS 31 DIN 7708.

## 1106C PLAIN KNOB C WITH THREADED HOLE

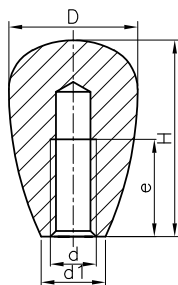

Code	D	d	d1	e	H	Color
110619101	19	M5	10	15	30	Black
110622101	22	M6	13	19	34	Black
110629101	29	M8	15	23	44	Black
110635101	35	M10	16	25	51	Black
110637101	37	M10	17	25	58	Black

Molded thread.  
PF: Black Duroplast FS 31 DIN 7708.  
Available in red similar RAL 3011.  
Please ask!

## 1106T PLAIN KNOB T WITH THREADED STUD

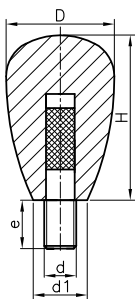

Code	D	d	d1	e	H	Color
110622501	22	M6	13	15	34	Black
110629501	29	M8	15	15	44	Black
110635501	35	M10	16	15	51	Black
110637501	37	M10	17	15	58	Black

Treated threaded steel stud.  
PF: Black Duroplast FS 31 DIN 7708.

## 4707C TMP PLAIN KNOB C WITH THREADED HOLE

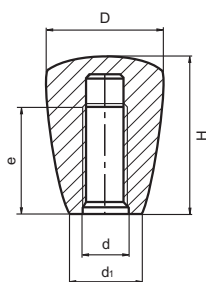

Code	D	d	d1	e	H	Color
470721101	21	M6	13	20	28	Black
470725101	25	M6	16	22	34	Black
470732101	32	M8	20	28	43	Black
470743101	43	M10	27	35	58	Black

Molded thread.  
PA: Reinforced polyamide.  
Other thread, plain hole or brass or SS insert on demand  
(min. 500 units).  
For different colours, please ask.

## 4707T TMP PLAIN KNOB T WITH THREADED STUD

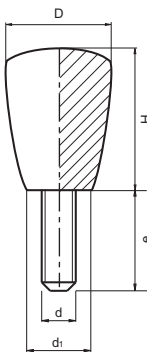

Code	D	d	e	d1	H	Color
470721502	21	M6	20	16	28	Black
470725502	25	M6	25	16	34	Black
470732501	32	M8	30	20	43	Black
470743501	43	M10	30	27	58	Black

Treated stud.  
PA: Polyamide.  
Different stud lengths or threads on demand  
(min. 500 units).  
For different colours, please ask.

## 1112 KNURLED OVAL KNOB C WITH THREADED HOLE

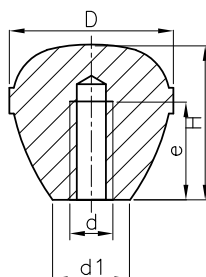

Code	D	d	d1	e	H	Color
111219101	19	M5	9	8	18	Black
111223101	23	M6	11	14	23	Black
111226101	26	M6	12	14	25	Black
111231101	31	M8	14	16	29	Black
111235101	35	M10	16	20	35	Black
111241101	41	M10	18	20	39	Black
111248101	48	M12	21	24	48	Black

Molded thread.  
PF: Black Duroplast FS 31 DIN 7708.

## 1113 TAPERED KNOB C WITH THREADED HOLE

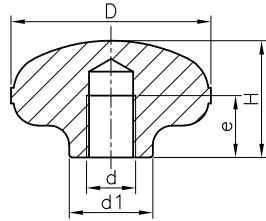

Code	D	d	d1	e	H	Color
111326101	26	M6	10	10	15	Black
111331101	31	M8	13	13	19	Black
111341101	41	M10	17	15	24	Black

Molded thread.  
PF: Black Duroplast FS 31 DIN 7708.

## 1116 C.M. KNOB WITH THREADED HOLE

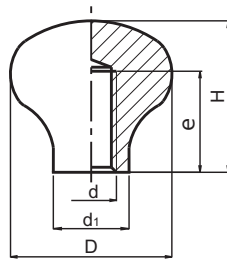

Code	D	H	d	e	d1	Color
111632101	32	30	M8	16	15	Black
111650101	50	40	M12	24	23	Black

Molded thread.  
PF: Black Duroplast FS 31 DIN 7708.

## 1117 LID KNOB WITH THREADED HOLE

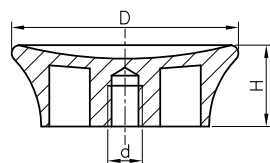

Code	D	d	H	Color
111733101	33	W 1/4"	16	Black
111741101	41	W 1/4"	18	Black

Molded thread.  
PF: Black Duroplast FS 31 DIN 7708.

## 1118K STAR-STUB K WITH THREADED INSERT

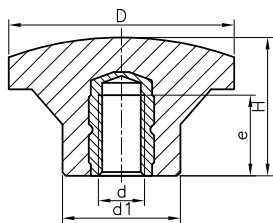
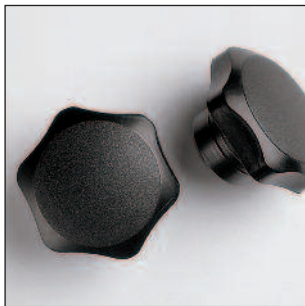

Threaded female brass insert.  
PF: Black Duroplast FS 31 DIN 7708.

Code	D	H	d	d1	e	Color
111822303	22	19	M5	12	9	Black
111822302	22	19	M6	12	10	Black
111833304	33	24	M6	19	10	Black
111833303	33	24	M8	19	14	Black
111844303	44	27	M8	23	14	Black
111844305	44	27	M10	23	17	Black
111855306	55	34	M8	25	14	Black
111855308	55	34	M10	25	17	Black
111866302	66	42	M12	30	19	Black
111877303	77	46	M12	30	19	Black

## 1118K STAR-STUB K SS WITH THREADED INSERT

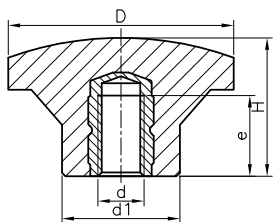
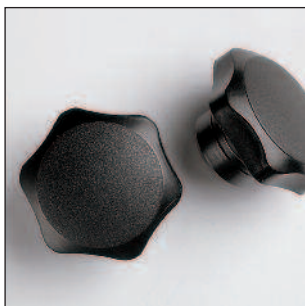

Threaded female stainless-steel AISI-303 insert.  
PF: Black Duroplast FS 31 DIN 7708.

Code	D	H	d	d1	e	Color
111833307	33	24	M6	19	10	Black
111844308	44	27	M8	23	14	Black
111855310	55	34	M10	25	17	Black



## 1118H STAR-STUB H WITH SMOOTH HOLE INSERT

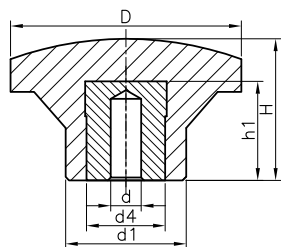

Treated steel insert.  
PF: Black Duroplast FS 31 DIN 7708.

Code	D	H	d	d1	d4	h1	Color
111822301	22	19	5,25	12	8	12	Black
111833301	33	24	5,25	19	14	17	Black
111844301	44	27	5,25	23	18	22	Black
111855301	55	34	5,25	25	18	22	Black
111866301	66	42	5,25	30	18	22	Black
111877301	77	46	5,25	30	18	22	Black

## 1118S STAR-STUB S WITH SMOOTH HOLE HUB

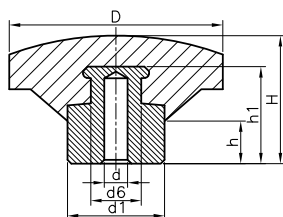

Zinc-plated steel hub.  
PF: Black Duroplast FS 31 DIN 7708.

Code	D	d	d6	d1	h	h1	H	Color
111844601	44	5,25	19	23	10	20	26	Black
111855601	55	5,25	19	25	11	29	32	Black
111866601	66	5,25	18	30	16	26	41	Black
111877601	77	5,25	18	30	16	26	43	Black

## 1118T STAR-STUB T WITH THREADED STEEL STUD

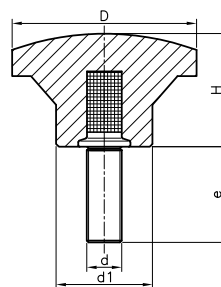

Treated threaded steel stud.  
PF: Black Duroplast FS 31 DIN 7708.

Code	D	H	d	e	d1	Color
111822513	22	19	M5	10	12	Black
111822502	22	19	M5	20	12	Black
111822511	22	19	M6	10	12	Black
111822501	22	19	M6	20	12	Black
111822514	22	19	M6	30	12	Black
111833502	33	24	M6	15	19	Black
111833538	33	24	M6	20	19	Black
111833539	33	24	M6	25	19	Black
111833505	33	24	M6	30	19	Black
111833520	33	24	M6	40	19	Black
111833512	33	24	M8	20	19	Black
111833501	33	24	M8	27	19	Black
111833540	33	24	M8	33	19	Black
111833541	33	24	M8	40	19	Black
111844504	44	27	M8	15	23	Black
111844502	44	27	M8	27	23	Black

Code	D	H	d	e	d1	Color
111844513	44	27	M8	33	23	Black
111844516	44	27	M8	40	23	Black
111844523	44	27	M8	47	23	Black
111844508	44	27	M10	20	23	Black
111844501	44	27	M10	33	23	Black
111844524	44	27	M10	44	23	Black
111844525	44	27	M10	64	23	Black
111855511	55	34	M10	20	25	Black
111855502	55	34	M10	33	25	Black
111855512	55	34	M10	44	25	Black
111855513	55	34	M10	64	25	Black
111855501	55	34	M12	40	25	Black
111866508	66	42	M12	40	30	Black
111866507	66	42	M12	60	30	Black
111877502	77	46	M12	40	30	Black

## 1118T STAR-STUB T WITH THREADED SS STUD

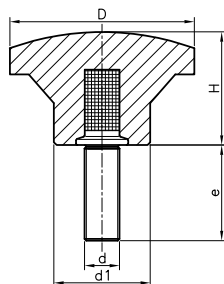

Stainless-steel A2 threaded stud.  
PF: Black Duroplast FS 31 DIN 7708.



Code	D	H	d	e	d1	Color
111822517	22	19	M5	16	12	Black
111833542	33	24	M6	10	19	Black
111833543	33	24	M6	20	19	Black
111844526	44	27	M8	16	23	Black
111844527	44	27	M8	25	23	Black
111855514	55	34	M10	20	25	Black
111855515	55	34	M10	30	25	Black
111866509	66	42	M12	25	30	Black
111866510	66	42	M12	35	30	Black

## 1120H FORZA H WITH SMOOTH HOLE INSERT

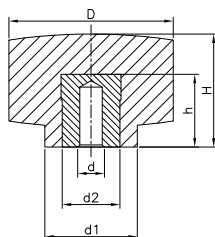

Treated steel insert.  
PF: Black Duroplast FS 31 DIN 7708.

Code	D	H	d	d1	d2	h	Color
112025301	25	19	5,25	16	12	15	Black
112032301	32	22	5,25	18	12	15	Black
112040301	40	27	5,25	21	14	17	Black
112050301	50	31	5,25	23	18	22	Black



## 1120K FORZA K WITH THREADED INSERT

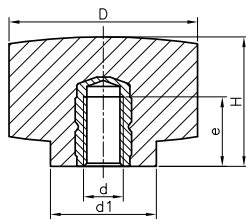

Code	D	H	d	d1	e	Color
112025303	25	19	M6	16	10	Black
112032306	32	22	M6	18	10	Black
112040306	40	27	M8	21	14	Black
112050306	50	31	M8	23	14	Black

Threaded female brass insert.  
PF: Black Duroplast FS 31 DIN 7708.

## 1120T FORZA T WITH THREADED STUD

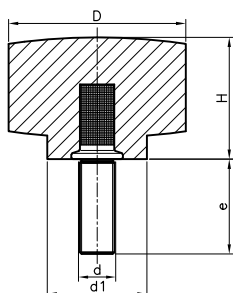

Code	D	H	d	e	d1	Color
112025501	25	19	M6	20	16	Black
112032501	32	22	M6	25	18	Black
112040501	40	27	M8	27	21	Black
112050501	50	31	M10	33	23	Black

Treated threaded steel stud.  
PF: Black Duroplast FS 31 DIN 7708.

## 1121K DIN 6335 K WITH THREADED INSERT

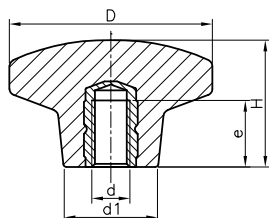

Code	D	H	d	d1	e	Color
112120301	20	14	M4	10	8	Black
112125301	25	15	M5	12	9	Black
112132301	32	20	M6	14	10	Black
112140301	40	26	M8	18	14	Black
112150301	50	32	M10	22	17	Black
112163301	63	38	M12	26	19	Black
112180301	80	50	M16	32	27	Black

Threaded female brass insert.  
PF: Black Duroplast FS 31 DIN 7708.

## 1121K DIN 6335 K WITH THREADED SS INSERT

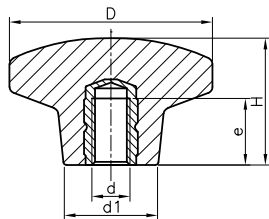

Code	D	H	d	d1	e	Color
112132304	32	20	M6	14	10	Black
112140308	40	26	M8	18	14	Black
112150311	50	32	M10	22	17	Black

Threaded female stainless-steel AISI-303 insert.  
PF: Black Duroplast FS 31 DIN 7708.

## 1121H DIN 6335 H WITH SMOOTH HOLE INSERT

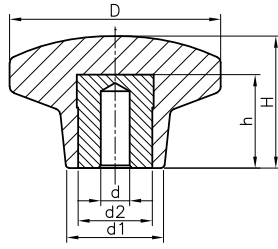

Code	D	H	d	d2	d1	h	Color
112140302	40	26	5,25	12	18	15	Black
112150302	50	32	5,25	14	22	17	Black
112163302	63	38	5,25	18	26	22	Black
112180302	80	50	5,25	18	32	22	Black

Treated steel insert.  
PF: Black Duroplast FS 31 DIN 7708.

## 1121D DIN 6335 D WITH THREADED THROUGH-HOLE INSERT

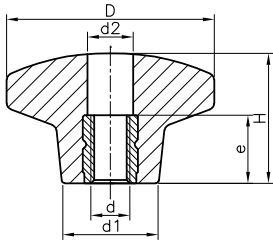

Code	D	H	d	d1	d2	e	Color
112120401	20	14	M4	10	4,3	8	Black
112125401	25	15	M5	12	5,3	7	Black
112132401	32	20	M6	14	6,4	10	Black
112140401	40	26	M8	18	8,4	14	Black
112150401	50	32	M10	22	10,5	16	Black
112163401	63	38	M12	26	13	18	Black
112180401	80	50	M16	32	17	20	Black

Brass threaded through hole insert.  
PF: Black Duroplast FS 31 DIN 7708.

## 1121T DIN 6335 T WITH THREADED STUD

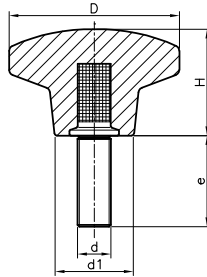

Threaded Zinc plated steel stud.  
PF: Black Duroplast FS 31 DIN 7708.

Code	D	H	d	e	d1	Color
112120501	20	14	M4	15	10	Black
112120523	20	14	M5	10	10	Black
112120522	20	14	M5	20	10	Black
112125501	25	15	M5	20	12	Black
112132510	32	20	M6	10	14	Black
112132512	32	20	M6	15	14	Black
112132501	32	20	M6	20	14	Black
112132503	32	20	M6	25	14	Black
112132511	32	20	M6	30	14	Black
112132502	32	20	M6	40	14	Black
112140512	40	26	M6	15	18	Black
112140522	40	26	M6	20	18	Black
112140513	40	26	M6	25	18	Black
112140514	40	26	M6	30	18	Black
112140515	40	26	M6	40	18	Black
112140508	40	26	M8	20	18	Black
112140501	40	26	M8	27	18	Black
112140516	40	26	M8	33	18	Black

Code	D	H	d	e	d1	Color
112140517	40	26	M8	40	18	Black
112140502	40	26	M8	47	18	Black
112150514	50	32	M8	20	22	Black
112150522	50	32	M8	33	22	Black
112150515	50	32	M8	47	22	Black
112150503	50	32	M10	20	22	Black
112150516	50	32	M10	33	22	Black
112150501	50	32	M10	44	22	Black
112150502	50	32	M10	64	22	Black
112163511	63	38	M10	20	26	Black
112163522	63	38	M10	33	26	Black
112163512	63	38	M10	44	26	Black
112163503	63	38	M10	64	26	Black
112163501	63	38	M12	40	26	Black
112163502	63	38	M12	60	26	Black
112180522	80	50	M12	40	32	Black
112180501	80	50	M16	55	32	Black
112180502	80	50	M16	75	32	Black

## 1121T DIN 6335 T WITH THREADED SS STUD

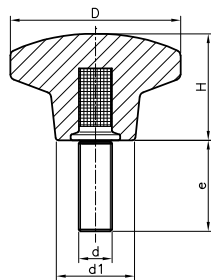

Threaded stainless-steel A2 stud.  
PF: Black Duroplast FS 31 DIN 7708.



Code	D	H	d	e	d1	Color
112132515	32	20	M6	10	14	Black
112132516	32	20	M6	20	14	Black
112140520	40	26	M6	16	18	Black
112140521	40	26	M8	16	18	Black
112140523	40	26	M8	25	18	Black
112150530	50	32	M8	20	22	Black
112150531	50	32	M10	20	22	Black
112150532	50	32	M10	30	22	Black
112163513	63	38	M10	25	26	Black
112163514	63	38	M12	25	26	Black
112163515	63	38	M12	35	26	Black
112180506	80	50	M12	30	32	Black

## 1124K SZ K WITH THREADED INSERT

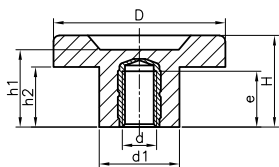

Threaded female brass insert.  
PF: Black Duroplast FS 31 DIN 7708.

Code	D	H	h1	h2	d	d1	e	Color
112430302	30	25	24	16	M6	20	10	Black
112430311	30	25	24	16	M8	20	14	Black
112445311	45	28	25	17	M8	24	14	Black
112445306	45	28	25	17	M10	24	17	Black
112460311	60	32	28	21	M8	28	14	Black
112460303	60	32	28	21	M10	28	17	Black
112460307	60	32	28	21	M12	28	19	Black

## 1124H SZ H WITH SMOOTH HOLE INSERT

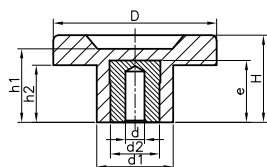

Treated steel insert.  
PF: Black Duroplast FS 31 DIN 7708.

Code	D	H	h1	h2	d	d1	d2	e	Color
112430301	30	25	24	16	5.25	20	14	17	Black
112445301	45	28	25	17	5.25	24	18	22	Black
112460301	60	32	28	21	5.25	28	18	22	Black

## 1124D SZ D WITH THREADED THROUGH-HOLE INSERT

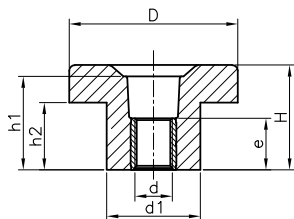

Brass threaded through hole insert.  
PF: Black Duroplast FS 31 DIN 7708.  
We can manufacture these articles with stainless-steel insert. Please ask.

Code	D	H	h1	h2	d	d1	e	Color
112430411	30	25	24	16	M6	20	11,5	Black
112430409	30	25	24	16	M8	20	13,8	Black
112445411	45	28	25	17	M8	24	13,8	Black
112445407	45	28	25	17	M10	24	13,8	Black
112460412	60	32	28	21	M8	28	13,8	Black
112460410	60	32	28	21	M10	28	13,8	Black
112460411	60	32	28	21	M12	28	13,8	Black

## 1124D\* SZ D\* WITH SMOOTH THROUGH-HOLE INSERT

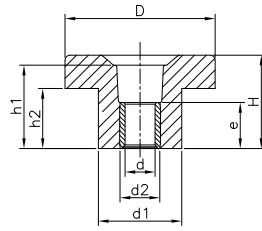

Code	D	H	h1	h2	d	d1	d2	e	Color
112430421	30	25	24	16	5,25	20	10	11,5	Black
112445421	45	28	25	17	5,25	24	12	13,8	Black
112460421	60	32	28	21	5,25	28	12	13,8	Black

Treated steel through hole insert.  
PF: Black Duroplast FS 31 DIN 7708.

## 1124T SZ T WITH THREADED STUD

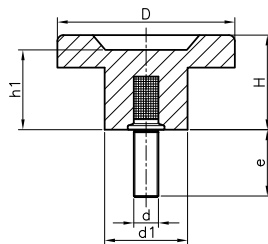

Code	D	H	h1	d	e	d1	Color
112430507	30	25	24	M8	27	20	Black
112445509	45	28	25	M10	33	24	Black
112460506	60	32	28	M12	40	28	Black

Treated threaded steel stud.  
PF: Black Duroplast FS 31 DIN 7708.

## 1125H CL H WITH SMOOTH HOLE INSERT

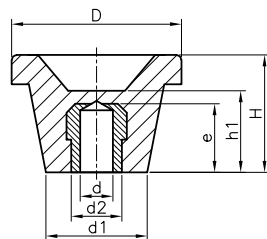

Code	D	H	d	e	d2	h1	d1	Color
112537302	37	30	5,25	17	14	21	22	Black
112544302	44	34	5,25	17	14	24	26	Black
112552302	52	36	5,25	22	18	25	31	Black
112560302	60	41	5,25	22	18	27	36	Black
112570302	70	44	5,25	22	18	29	38	Black
112580302	80	45	5,25	22	18	30	37	Black
112590302	90	46	5,25	22	18	31	40	Black

Treated steel insert.  
PF: Black Duroplast FS 31 DIN 7708.

## 1125T CL T WITH THREADED STUD

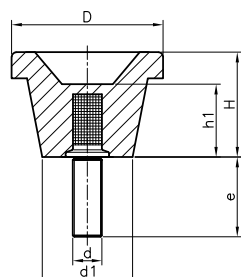

Code	D	H	d	e	h1	d1	Color
112537501	37	30	M8	27	21	22	Black
112544501	44	34	M10	33	24	26	Black
112552501	52	36	M10	33	25	31	Black
112560501	60	41	M12	40	27	36	Black
112570503	70	44	M12	40	29	38	Black
112580501	80	45	M16	55	30	37	Black

Treated threaded steel stud.  
PF: Black Duroplast FS 31 DIN 7708.

## 1126K DIN 6336 K WITH THREADED INSERT

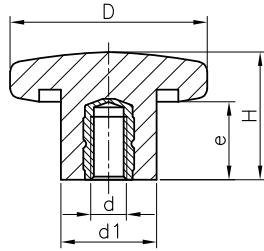

Code	D	H	d	e	d1	Color
112620301	20	13	M4	8	10	Black
112625301	25	16	M5	9	12	Black
112632301	32	20	M6	10	13	Black
112640301	40	25	M8	14	19	Black
112650301	50	32	M10	17	20	Black
112663301	63	40	M12	19	23	Black
112680301	80	50	M16	27	30	Black

Threaded female brass insert.  
PF: Black Duroplast FS 31 DIN 7708.

## 1126T DIN 6336 T WITH THREADED STUD

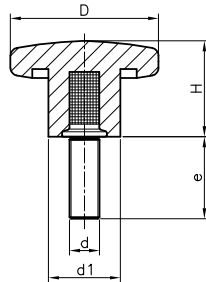

Code	D	H	d	e	d1	Color
112620501	20	13	M4	15	10	Black
112625501	25	16	M5	20	12	Black
112632504	32	20	M6	15	13	Black
112632501	32	20	M6	20	13	Black
112632506	32	20	M6	25	13	Black
112632509	32	20	M6	30	13	Black
112632502	32	20	M6	40	13	Black
112640503	40	25	M8	20	19	Black
112640501	40	25	M8	27	19	Black
112640514	40	25	M8	33	19	Black
112640506	40	25	M8	40	19	Black
112640502	40	25	M8	47	19	Black
112650511	50	32	M10	20	20	Black
112650512	50	32	M10	33	20	Black
112650501	50	32	M10	44	20	Black
112650502	50	32	M10	64	20	Black
112663501	63	40	M12	40	23	Black
112663502	63	40	M12	60	23	Black
112680501	80	50	M16	55	30	Black
112680502	80	50	M16	75	30	Black

Treated threaded steel stud.  
PF: Black Duroplast FS 31 DIN 7708.

## 1133H THREE PRONG KNOB H WITH SMOOTH HOLE INSERT

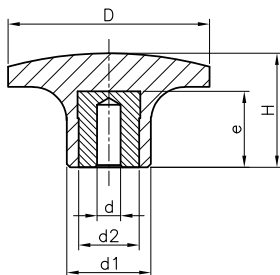

Code	D	H	d	e	d2	d1	Color
113330305	30	17	5,25	12	8	11	Black
113340305	40	22	5,25	14	10	15	Black
113350305	50	26	5,25	17	14	20	Black
113360305	60	30	5,25	22	18	25	Black

Treated steel insert.  
PF: Black Duroplast FS 31 DIN 7708.

## 1133S THREE PRONG KNOB S WITH SMOOTH HOLE HUB

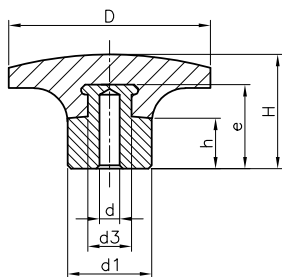

Code	D	H	d	e	d1	d3	h	Color
113330601	30	18	5,25	14	11	8	6	Black
113340601	40	24,5	5,25	18	15	11	8	Black
113350601	50	29	5,25	22	20	15	11	Black
113360601	60	34	5,25	29	25	19	15	Black

Zinc-plated steel hub.  
PF: Black Duroplast FS 31 DIN 7708.

## 1133T THREE PRONG KNOB T WITH THREADED STUD

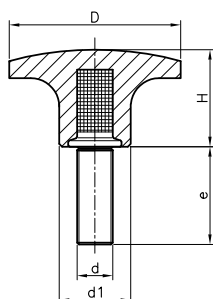

Code	D	H	d	e	d1	Color
113330501	30	17	M6	25	11	Black
113340511	40	22	M8	33	15	Black
113350525	50	26	M10	33	20	Black
113360525	60	30	M12	40	25	Black

Treated threaded steel stud.  
PF: Black Duroplast FS 31 DIN 7708.

## 1195H LGN H WITH SMOOTH HOLE INSERT

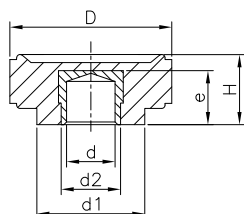

Code	D	H	d	e	d1	d2	Color
119524301	24	13	5,25	8	14	10	Black
119530301	30	15	5,25	12	20	12	Black

Treated steel insert.  
PF: Black Duroplast FS 31 DIN 7708.

## 1195D LGN D WITH THREADED THROUGH-HOLE INSERT

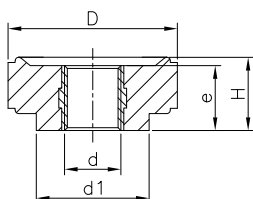

Code	D	H	d	e	d1	Color
119524407	24	13	M6	11,5	14	Black
119530409	30	15	M8	13,8	20	Black
119530405	30	15	M10	13,8	20	Black

Brass threaded through hole insert.  
PF: Black Duroplast FS 31 DIN 7708.

## 1195D\* LGN D\* WITH SMOOTH THROUGH-HOLE INSERT

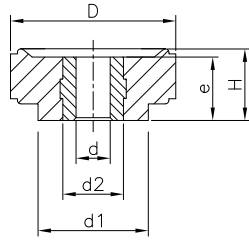

Code	D	H	d	e	d1	d2	Color
119524401	24	13	5,25	11,5	14	10	Black
119530401	30	15	5,25	13,8	20	12	Black

Treated steel through hole insert.  
PF: Black Duroplast FS 31 DIN 7708.

## 1195T LGN T WITH THREADED STUD

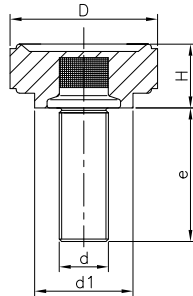

Code	D	H	d	e	d1	Color
119524501	24	13	M6	25	14	Black
119524543	24	13	M8	10	14	Black
119524544	24	13	M8	27	14	Black
119530501	30	15	M10	13	20	Black

Treated threaded steel stud.  
PF: Black Duroplast FS 31 DIN 7708.

## 1115 KN T WITH THREADED STUD



Treated threaded stud blackened.  
POM: Acetate resin.

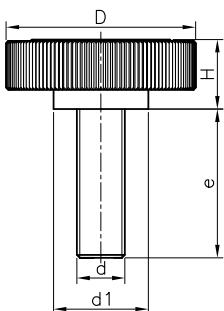

Black Code	Red Code	Grey Code	D	H	d1	d	e
111509108	111509408	111509708	9.5	5	8	M3	8
111509110	111509410	111509710	9.5	5	8	M3	10
111509112	111509412	111509712	9.5	5	8	M3	12
111513110	111513410	111513710	13	6	10	M4	10
111513112	111513412	111513712	13	6	10	M4	12
111513114	111513414	111513714	13	6	10	M4	14
111516112	111516412	111516712	16	7	12	M5	12
111516114	111516414	111516714	16	7	12	M5	14
111516116	111516416	111516716	16	7	12	M5	16
111519114	111519414	111519714	19	7	13	M6	14
111519116	111519416	111519716	19	7	13	M6	16
111519120	111519420	111519720	19	7	13	M6	20
111526114	111526414	111526714	26	9	16	M6	14
111526116	111526416	111526716	26	9	16	M6	16
111526120	111526420	111526720	26	9	16	M6	20
111527116	111527416	111527716	26	9	16	M8	16
111527120	111527420	111527720	26	9	16	M8	20
111527125	111527425	111527725	26	9	16	M8	25

## 1134K CAP K WITH THREADED INSERT

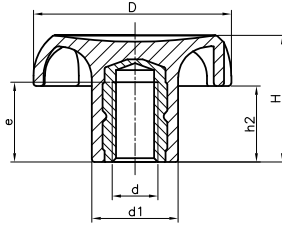
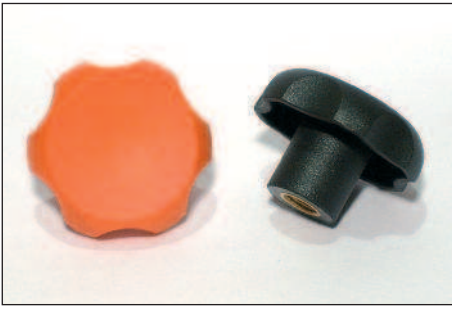

Code	D	H	d1	d	e	h2	Color
113432301	32	20	13	M5	9	11	Black
113432303	32	20	13	M6	10	11	Black
113440301	40	25	17	M6	10	15	Black
113440302	40	25	17	M8	14	15	Black
113440303	40	25	17	M10	17	15	Black
113432353	32	20	13	M5	9	11	Orange
113432356	32	20	13	M6	10	11	Orange
113440356	40	25	17	M6	10	15	Orange
113440357	40	25	17	M8	14	15	Orange
113440358	40	25	17	M10	17	15	Orange

Threaded female brass insert.  
PA: Black or Orange reinforced polyamide.

RAL 7021  
 RAL 2004

## 1134K CAP K WITH THREADED SS INSERT

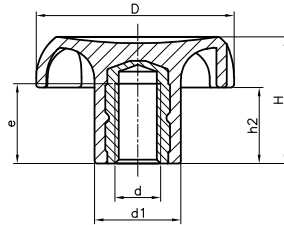

Code	D	H	d1	d	e	h2	Color
113432302	32	20	13	M6	10	11	Black
113440306	40	25	17	M8	14	15	Black

Threaded female Stainless-steel AISI-303 insert.  
PA: Black reinforced polyamide.

RAL 7021



## 1134T CAP T WITH THREADED STUD



Treated threaded steel stud.  
PA: Black reinforced polyamide.

RAL 7021  
 RAL 2004

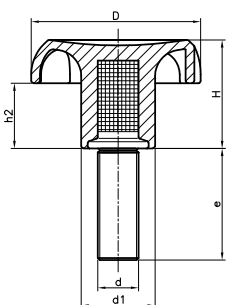

Black Code	Orange Code	D	H	d1	d	e	h2
113432505	113432545	32	20	13.5	M5	20	11
113432503	113432543	32	20	13.5	M6	10	11
113432501	113432541	32	20	13.5	M6	20	11
113432504	113432544	32	20	13.5	M6	30	11
113432506	113432546	32	20	13.5	M6	40	11
113432508	113432547	32	20	13.5	M8	20	11
113432502	113432542	32	20	13.5	M8	27	11
113432509	113432548	32	20	13.5	M8	47	11
113440511	113440551	40	25	17	M6	15	15
113440501	113440541	40	25	17	M6	20	15
113440504	113440544	40	25	17	M6	30	15
113440505	113440545	40	25	17	M6	40	15
113440515	113440555	40	25	17	M8	15	15
113440506	113440546	40	25	17	M8	20	15
113440507	113440547	40	25	17	M8	33	15
113440508	113440548	40	25	17	M8	47	15
113440509	113440549	40	25	17	M10	20	15
113440503	113440543	40	25	17	M10	33	15
113440510	113440550	40	25	17	M10	44	15



## 1134T CAP T WITH THREADED SS STUD

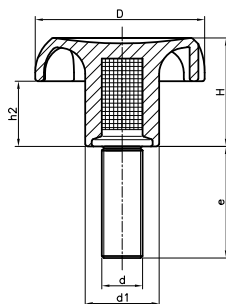
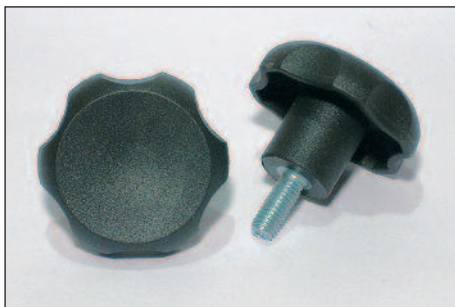

Code	D	H	d1	d	e	h2	Color
113432507	32	20	13,5	M6	16	11	Black
113440521	40	25	17	M6	16	15	Black
113440518	40	25	17	M8	20	15	Black
113440514	40	25	17	M8	25	15	Black

Threaded stainless-steel A2 stud.  
PA: Black reinforced polyamide.

■ RAL 7021



## 1138C MTC C WITH THREADED HOLE

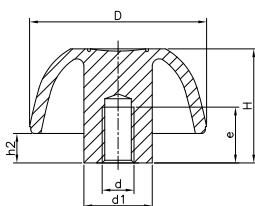

Code	D	H	d1	d	e	h2	Color
113825101	25	17	12	M5	12	6	Black
113832101	32	20	14	M6	15	6	Black
113840101	40	25	17	M8	20	7	Black
113850101	50	32	19	M10	24	8	Black

Moulded thread.  
PA: Black reinforced polyamide.

## 1138K MTC K WITH THREADED INSERT



Threaded female brass insert.  
PA: Black or Orange reinforced polyamide.

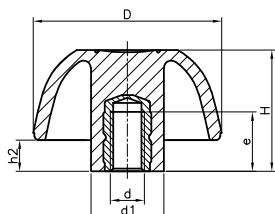

Black Code	Orange Code	D	H	d1	d	e	h2
113825302	113825342	25	17	12	M4	8,5	6
113825303	113825343	25	17	12	M5	9	6
113825301	113825341	25	17	12	M6	10	6
113832303	113832343	32	20	14	M5	9	6
113832301	113832341	32	20	14	M6	10	6
113840301	113840341	40	25	17	M6	10	7
113840302	113840342	40	25	17	M8	14	7
113840303	113840343	40	25	17	M10	17	7
113850301	113850341	50	32	19	M8	14	8
113850302	113850342	50	32	19	M10	17	8
113850308	113850345	50	32	19	M12	19	8
113863301	113863341	63	40	23	M10	17	11
113863302	113863342	63	40	23	M12	19	11
113863306	113863344	63	40	23	M16	27	11

■ RAL 7021

■ RAL 2004

## 1138K MTC K WITH THREADED SS INSERT

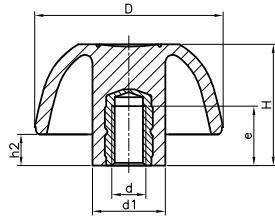

Code	D	H	d1	d	e	h2	Color
113832302	32	20	14	M6	10	6	Black
113840306	40	25	17	M8	14	7	Black
113850304	50	32	19	M10	17	8	Black

Threaded female stainless steel AISI-303 insert.  
PA: Black reinforced polyamide.

RAL 7021



## 1138D MTC D WITH THREADED THROUGH-HOLE INSERT



Black Code	Orange Code	D	H	d1	d	e	h2
113825404	113825444	25	17	12	M4	11,5	5
113825405	113825445	25	17	12	M5	11,5	5
113825401	113825441	25	17	12	M6	11,5	5
113832405	113832445	32	20	14	M5	11,5	6
113832401	113832441	32	20	14	M6	11,5	6
113840401	113840441	40	25	17	M6	11,5	7
113840403	113840443	40	25	17	M8	13,8	7
113840402	113840442	40	25	17	M10	13,8	7
113850401	113850441	50	32	19	M8	13,8	8
113850402	113850443	50	32	19	M10	13,8	8
113850405	113850445	50	32	19	M12	13,8	8
113863401	113863441	63	40	23	M10	13,8	11
113863402	113863442	63	40	23	M12	13,8	11

Brass threaded through hole insert.  
PA: Black or Orange reinforced polyamide.

RAL 7021

RAL 2004

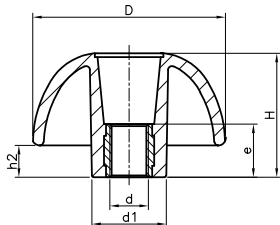

## 1138D INOX MTC D WITH THREADED THROUGH-HOLE SS INSERT



Code	D	H	d1	d	e	h2	Color
113825420	25	17	12	M6	11.5	5	Black
113832403	32	20	14	M6	11.5	6	Black
113840420	40	25	17	M6	11.5	7	Black
113840421	40	25	17	M8	13.8	7	Black
113850420	50	32	19	M8	13.8	8	Black
113850421	50	32	19	M10	13.8	8	Black
113863420	63	40	23	M10	13.8	11	Black

Stainless steel threaded through hole insert.  
PA: Black reinforced polyamide.

RAL 7021

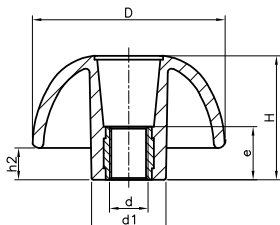

## 1138T MTC T WITH THREADED STUD

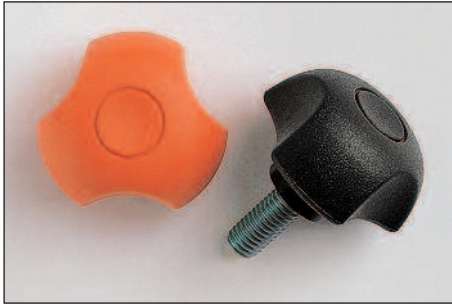

Treated threaded steel stud.  
PA: Black or Orange reinforced polyamide.

RAL 7021  
 RAL 2004

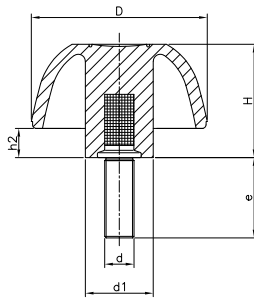

Black Code	Orange Code	D	H	d1	d	e	h2
113825502	113825542	25	17	12	M4	15	6
113825503	113825543	25	17	12	M5	20	6
113825501	113825541	25	17	12	M6	20	6
113832515	113832548	32	20	14	M5	20	6
113832503	113832543	32	20	14	M6	10	6
113832501	113832541	32	20	14	M6	20	6
113832504	113832544	32	20	14	M6	30	6
113832502	113832542	32	20	14	M8	27	6
113832516	113832549	32	20	14	M8	40	6
113840511	113840552	40	25	17	M6	15	7
113840501	113840541	40	25	17	M6	20	7
113840504	113840544	40	25	17	M6	30	7
113840505	113840545	40	25	17	M6	40	7
113840515	113840553	40	25	17	M8	15	7
113840506	113840546	40	25	17	M8	20	7
113840507	113840547	40	25	17	M8	33	7
113840508	113840548	40	25	17	M8	47	7
113840509	113840549	40	25	17	M10	20	7
113840503	113840543	40	25	17	M10	33	7
113840510	113840542	40	25	17	M10	44	7
113850505	113850547	50	32	19	M8	15	8
113850502	113850542	50	32	19	M8	27	8
113850501	113850541	50	32	19	M8	40	8
113850503	113850543	50	32	19	M10	33	8
113850504	113850544	50	32	19	M10	50	8
113850516	113850551	50	32	19	M12	40	8
113850517	113850552	50	32	19	M12	60	8
113863503	113863543	63	40	23	M10	33	11
113863504	113863544	63	40	23	M12	40	11
113863501	113863545	63	40	23	M16	55	11

## 1138T MTC T WITH THREADED SS STUD



Threaded stainless-steel A2 stud.  
PA: Black reinforced polyamide.

RAL 7021

**INOX**  
 Stainless  
 Steel

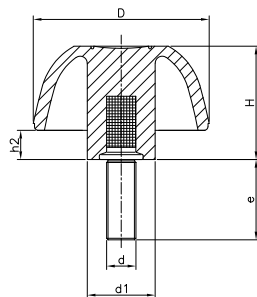

Code	D	H	d1	d	e	h2	Color
113825511	25	17	12	M4	12	6	Black
113832523	32	20	14	M5	16	6	Black
113832507	32	20	14	M6	16	6	Black
113840521	40	25	17	M6	16	8	Black
113840518	40	25	17	M8	20	8	Black
113840539	40	25	17	M8	25	8	Black
113850508	50	32	19	M10	20	9	Black
113850509	50	32	19	M10	30	9	Black
113863505	63	40	23	M12	30	12	Black

## 1139K STARPLAST K WITH THREADED INSERT

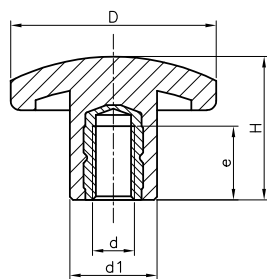
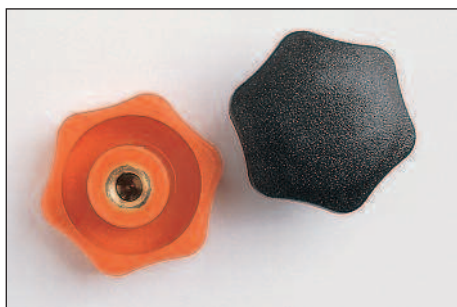

Code	D	H	d1	d	e	Color
113933301	33	22	14	M6	10	Black
113933302	33	22	14	M8	14	Black
113933341	33	22	14	M6	10	Orange
113933342	33	22	14	M8	14	Orange

Threaded female brass insert.  
PA: Black or Orange reinforced polyamide.

■ RAL 7021  
■ RAL 2004

## 1139T STARPLAST T WITH THREADED STUD

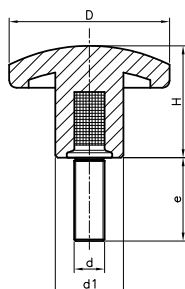
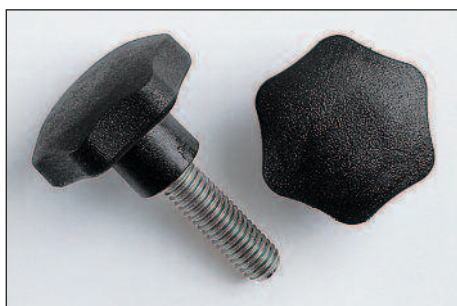

Code	D	H	d	e	d1	Color
113933504	33	22	M6	15	14	Black
113933501	33	22	M6	20	14	Black
113933505	33	22	M6	30	14	Black
113933506	33	22	M6	40	14	Black
113933507	33	22	M8	20	14	Black
113933502	33	22	M8	27	14	Black
113933508	33	22	M8	47	14	Black
113933544	33	22	M6	15	14	Orange
113933541	33	22	M6	20	14	Orange
113933545	33	22	M6	30	14	Orange
113933546	33	22	M6	40	14	Orange
113933547	33	22	M8	20	14	Orange
113933542	33	22	M8	27	14	Orange
113933548	33	22	M8	47	14	Orange

Treated threaded steel stud.  
PA: Black or Orange reinforced polyamide.

■ RAL 7021  
■ RAL 2004

## 1168K SAFETY K WITH THREADED INSERT

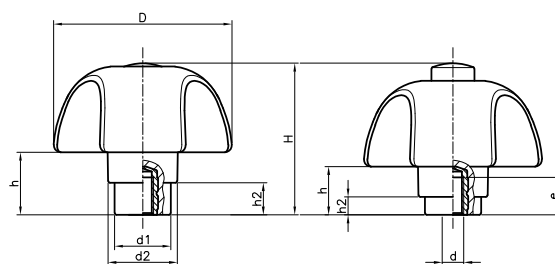

REST POSITION

WORKING POSITION

D	h	h2
50	17,5	9

D	h	h2
50	13,5	5

Threaded female brass insert, spring in stainless-steel.  
PA: Black reinforced polyamide with caps in colours: black, orange, red, blue, yellow and grey similar to the RAL indicated below.

Great knob for safety applications.  
This knob only turns when pressed downward and turned simultaneously to avoid involuntary turning.

■ RAL 7021   ■ RAL 5005  
■ RAL 2004   ■ RAL 1021  
■ RAL 3001   ■ RAL 7038



Black Code	Orange Code	Red Code	Blue Code	Yellow Code	Grey Code	D	H	d	e	d1	d2	Body
116853001	116853006	116853009	116853012	116853015	116853018	50	42	M6	10	16	19,5	Black
116853002	116853007	116853010	116853013	116853016	116853019	50	42	M8	14	16	19,5	Black
116853003	116853008	116853011	116853014	116853017	116853020	50	42	M10	13	16	19,5	Black

## 1168K SAFETY K WITH THREADED SS INSERT









**INOX**  
Stainless  
Steel

Threaded female Stainless-steel AISI-303 insert, spring in stainless-steel.

PA: Black reinforced polyamide with caps in colours: black, orange, red, blue, yellow and grey, similar to the RAL indicated below.

Great knob for safety applications.

This knob only turns when pressed downward and turned simultaneously to avoid involuntary turning.

	RAL 7021		RAL 5005
	RAL 2004		RAL 1021
	RAL 3001		RAL 7038

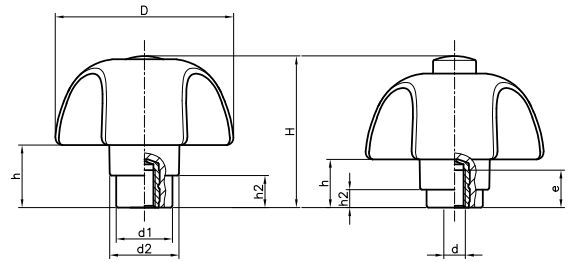

REST POSITION

D	h	h2
50	17,5	9

WORKING POSITION

D	h	h2
50	13,5	5



Black Code	Orange Code	Red Code	Blue Code	Yellow Code	Grey Code	D	H	d	e	d1	d2	Body
116853004	116853111	116853113	116853115	116853117	116853119	50	42	M6	10	16	19,5	Black
116853005	116853112	116853114	116853116	116853118	116853120	50	42	M8	14	16	19,5	Black

## 1168T SAFETY T WITH THREADED STUD









Treated threaded steel stud, spring in stainless-steel.

PA: Black reinforced polyamide, with caps in colours: black, orange, red, blue, yellow and grey, similar to the RAL indicated below.

Great knob for safety applications.

This knob only turns when pressed downward and turned simultaneously to avoid involuntary turning.

	RAL 7021		RAL 5005
	RAL 2004		RAL 1021
	RAL 3001		RAL 7038

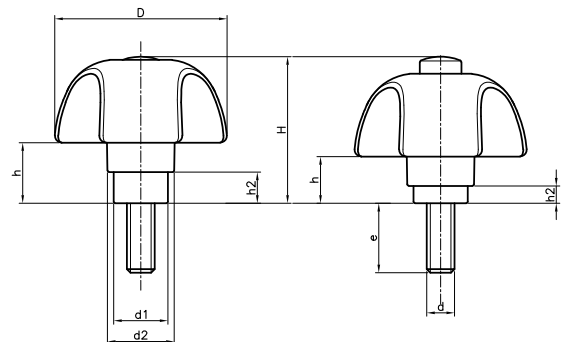

REST POSITION

D	h	h2
50	17,5	9

WORKING POSITION

D	h	h2
50	13,5	5

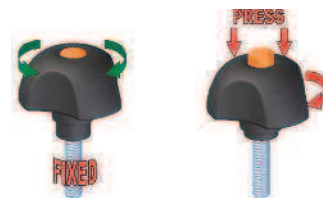

Black Code	Orange Code	Red Code	Blue Code	Yellow Code	Grey Code	D	H	d	e	d1	d2	Body
116855001	116855015	116855026	116855037	116855048	116855059	50	42	M6	15	16	19,5	Black
116855002	116855016	116855027	116855038	116855049	116855060	50	42	M6	20	16	19,5	Black
116855003	116855017	116855028	116855039	116855050	116855061	50	42	M6	30	16	19,5	Black
116855004	116855018	116855029	116855040	116855051	116855062	50	42	M6	40	16	19,5	Black
116855014	116855025	116855036	116855047	116855058	116855069	50	42	M8	15	16	19,5	Black
116855005	116855019	116855030	116855041	116855052	116855063	50	42	M8	20	16	19,5	Black
116855006	116855020	116855031	116855042	116855053	116855064	50	42	M8	33	16	19,5	Black
116855007	116855021	116855032	116855043	116855054	116855065	50	42	M8	47	16	19,5	Black
116855008	116855022	116855033	116855044	116855055	116855066	50	42	M10	20	16	19,5	Black
116855009	116855023	116855034	116855045	116855056	116855067	50	42	M10	30	16	19,5	Black
116855010	116855024	116855035	116855046	116855057	116855068	50	42	M10	40	16	19,5	Black

## 1168T SAFETY T WITH THREADED SS STUD

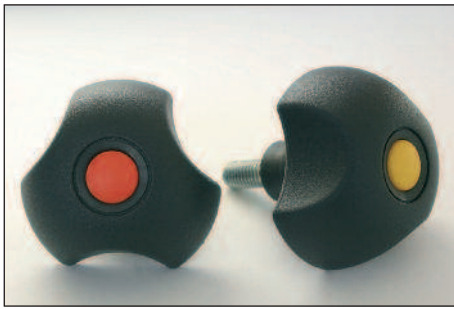







**INOX**  
Stainless  
Steel

Treated threaded stainless-steel stud,  
spring in stainless-steel.

PA: Black reinforced polyamide, with caps in colours:  
black, orange, red, blue, yellow and grey, similar to  
the RAL indicated below.

Great knob for safety applications.

This knob only turns when pressed downward and  
turned simultaneously to avoid involuntary turning.

	RAL 7021		RAL 5005
	RAL 2004		RAL 1021
	RAL 3001		RAL 7038

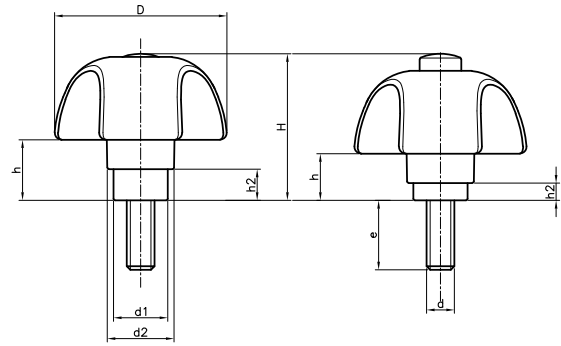

REST POSITION

WORKING POSITION

D	h	h2
50	17,5	9

D	h	h2
50	13,5	5

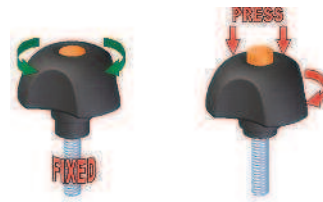

Black Code	Orange Code	Red Code	Blue Code	Yellow Code	Grey Code	D	H	d	e	d1	d2	Body
116855011	116855400	116855403	116855406	116855409	116855412	50	42	M6	15	16	19,5	Black
116855012	116855401	116855404	116855407	116855410	116855413	50	42	M8	20	16	19,5	Black
116855013	116855402	116855405	116855408	116855411	116855414	50	42	M8	40	16	19,5	Black

## 1196K CONTACT K WITH THREADED INSERT

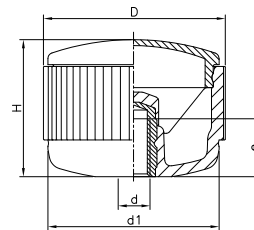
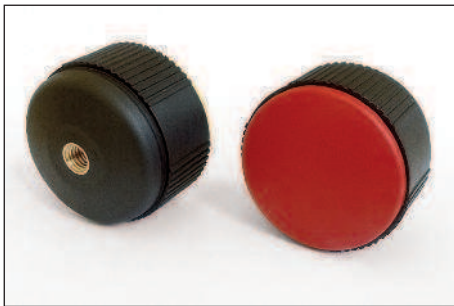

Threaded female brass insert.

PA: Black reinforced polyamide.

Caps on the following colours: black, orange, red, blue,  
yellow and grey, similar to the RAL indicated below.

Supplied with the cap not mounted.

	RAL 7021
	RAL 2004
	RAL 3001
	RAL 5005
	RAL 1021
	RAL 7038

Black Code	Orange Code	Red Code	Blue Code	Yellow Code	Grey Code	D	H	d	d1	e	Body
119641301	119644301	119645301	119642301	119643301	119649301	40	30	M6	37	10	Black
119641302	119644302	119645302	119642302	119643302	119649302	40	30	M8	37	14	Black
119641303	119644303	119645303	119642303	119643303	119649303	40	30	M10	37	17	Black
119651302	119654302	119655302	119652302	119653302	119659302	50	37	M8	46	14	Black
119651303	119654303	119655303	119652303	119653303	119659303	50	37	M10	46	17	Black

## 1196K CONTACT K WITH THREADED SS INSERT

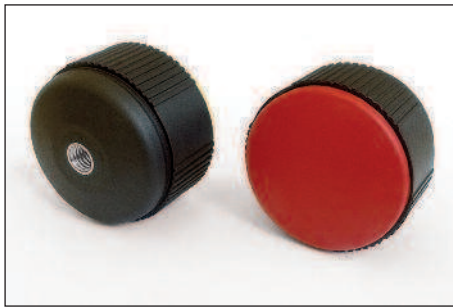

**INOX**  
Stainless  
Steel

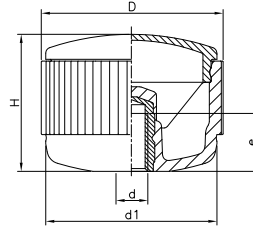







Threaded female stainless steel insert.

PA: Black reinforced polyamide.

Caps on the following colours: black, orange, red, blue, yellow and grey, similar to the RAL indicated below.

Supplied with the cap not mounted.

	Black Code	Orange Code	Red Code	Blue Code	Yellow Code	Grey Code	D	H	d	d1	e	Body
 RAL 7021	119641307	119644307	119645307	119642307	119643307	119649307	40	30	M6	37	10	Black
 RAL 2004	119641308	119644308	119645308	119642308	119643308	119649308	40	30	M8	37	14	Black
 RAL 3001	119651309	119654309	119655309	119652309	119653309	119659309	50	37	M8	46	14	Black
 RAL 5005	119651310	119654310	119655310	119652310	119653310	119659310	50	37	M10	46	17	Black
 RAL 1021												
 RAL 7038												

## 1196T CONTACT T WITH THREADED STUD

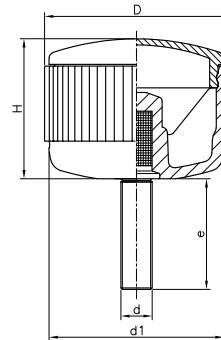
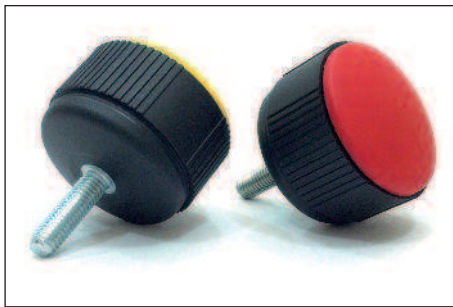







Treated threaded steel stud.

PA: Black reinforced polyamide.

Caps in the following colours: black, orange, red, blue, yellow and grey, similar to the RAL indicated below.

Supplied with the cap not mounted.

	Black Code	Orange Code	Red Code	Blue Code	Yellow Code	Grey Code	D	H	d1	d	e	Body
 RAL 7021	119641501	119644501	119645501	119642501	119643501	119649501	40	30	37	M6	15	Black
 RAL 2004	119641503	119644503	119645503	119642503	119643503	119649503	40	30	37	M6	30	Black
 RAL 3001	119641504	119644504	119645504	119642504	119643504	119649504	40	30	37	M6	40	Black
 RAL 5005	119641505	119644505	119645505	119642505	119643505	119649505	40	30	37	M8	15	Black
 RAL 1021	119641507	119644507	119645507	119642507	119643507	119649507	40	30	37	M8	33	Black
 RAL 7038	119641509	119644509	119645509	119642509	119643509	119649509	40	30	37	M8	47	Black
	119641510	119644510	119645510	119642510	119643510	119649510	40	30	37	M10	20	Black
	119641511	119644511	119645511	119642511	119643511	119649511	40	30	37	M10	33	Black
	119641512	119644512	119645512	119642512	119643512	119649512	40	30	37	M10	44	Black
	119651501	119654501	119655501	119652501	119653501	119659501	50	37	46	M8	15	Black
	119651502	119654502	119655502	119652502	119653502	119659502	50	37	46	M8	27	Black
	119651503	119654503	119655503	119652503	119653503	119659503	50	37	46	M8	40	Black
	119651504	119654504	119655504	119652504	119653504	119659504	50	37	46	M10	20	Black
	119651505	119654505	119655505	119652505	119653505	119659505	50	37	46	M10	33	Black
	119651506	119654506	119655506	119652506	119653506	119659506	50	37	46	M10	50	Black
	119651507	119654507	119655507	119652507	119653507	119659507	50	37	46	M12	40	Black
	119651508	119654508	119655508	119652508	119653508	119659508	50	37	46	M12	60	Black

## 1196T CONTACT T WITH THREADED SS STUD



**INOX**  
Stainless  
Steel

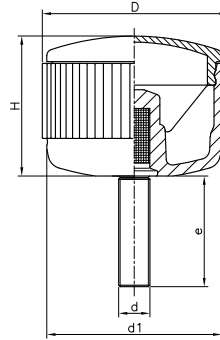







Threaded stainless-steel A2 stud.

PA: Black reinforced polyamide.

Caps in the following colours: black, orange, red, blue, yellow and grey, similar to the RAL indicated below.

Supplied with the cap not mounted.

	Black Code	Orange Code	Red Code	Blue Code	Yellow Code	Grey Code	D	H	d1	d	e	Body
 RAL 7021	119641524	119644524	119645524	119642524	119643524	119649524	40	30	37	M6	10	Black
 RAL 2004	119641525	119644525	119645525	119642525	119643525	119649525	40	30	37	M6	20	Black
 RAL 3001	119641526	119644526	119645526	119642526	119643526	119649526	40	30	37	M8	16	Black
 RAL 5005	119641527	119644527	119645527	119642527	119643527	119649527	40	30	37	M8	25	Black
 RAL 1021	119651520	119654520	119655520	119652520	119653520	119659520	50	37	46	M8	20	Black
 RAL 7038	119651521	119654521	119655521	119652521	119653521	119659521	50	37	46	M10	25	Black

## 3813K STAR KNOB K SS THREADED NUT

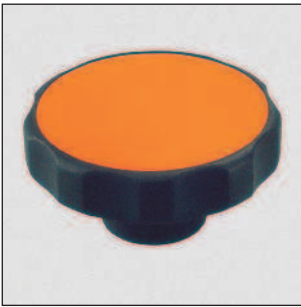



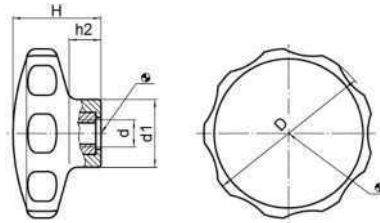

**INOX**  
Stainless  
Steel



Stainless steel nut.

PA: Polyamide.

 RAL 9005
 RAL 9019
 RAL 2004
 RAL 5025
 RAL 1016

Black Code	Orange Code	Red Code	Blue Code	Yellow Code	D	d	d1	H	h2	Body
381300030	381300031	381300032	381300033	381300034	30	M4	14	19	7	Black
381300035	381300036	381300037	381300038	381300039	30	M5	14	19	7	Black
381300040	381300041	381300042	381300043	381300044	40	M5	16.5	22	9	Black
381300045	381300046	381300047	381300048	381300049	40	M6	16.5	22	9	Black
381300050	381300051	381300052	381300053	381300054	50	M6	22	26	10	Black
381300055	381300056	381300057	381300058	381300059	50	M8	22	26	10	Black
381300060	381300061	381300062	381300063	381300064	62	M8	22	35	13	Black
381300065	381300066	381300067	381300068	381300069	62	M10	22	35	13	Black



## 3813T STAR KNOB T SS SCREW



**INOX**  
Stainless Steel

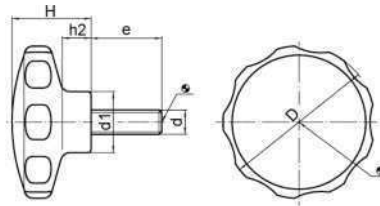

Stainless steel screw.  
PA: Polyamide.

	RAL 9005
	RAL 9019
	RAL 2004
	RAL 5025
	RAL 1016

Black Code	White Code	Orange Code	Yellow Code	Blue Code	D	d	e	d1	H	h2	Body
381300110	381300111	381300112	381300113	381300114	30	M4	14	14	19	7	Black
381300140	381300141	381300142	381300143	381300144	30	M4	28	14	19	7	Black
381300150	381300151	381300152	381300153	381300154	30	M5	10	14	19	7	Black
381300180	381300181	381300182	381300183	381300184	30	M5	23	14	19	7	Black
381300250	381300251	381300252	381300253	381300254	40	M6	14	16,5	22	9	Black
381300270	381300271	381300272	381300273	381300274	40	M6	23	16,5	22	9	Black
381300290	381300291	381300292	381300293	381300294	40	M6	38	16,5	22	9	Black
381300350	381300351	381300352	381300353	381300354	50	M8	18	22	26	10	Black
381300380	381300381	381300382	381300383	381300384	50	M8	38	22	26	10	Black
381300450	381300451	381300452	381300453	381300454	62	M10	23	22	35	13	Black
381300480	381300481	381300482	381300483	381300484	62	M10	48	22	35	13	Black

## 4701K 3L THREE PRONG KNOB K WITH THREADED INSERT



Brass insert.  
PA: Reinforced polyamide.

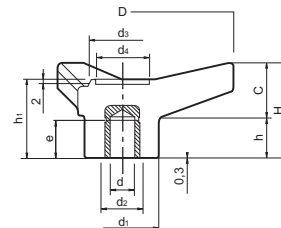

Code	D	H	d	d2	d3	d1	d4	h	h1	C	e	Color
470104301	45	21	M6	-	14.5	16	10	10	17.5	11	9	Black
470106301	65	28	M8	-	21	22	15	12	23	16	11	Black
470108301	85	36	M10	18	27	30	20	15	30	21	14	Black
470110301	105	45	M12	20	32	35	24	19	37	26	17	Black
470112301	125	53	M12	26	40	42	27	22.5	44	30.5	18	Black

## 4701D 3L THREE PRONG KNOB D WITH THREADED THROUGH-HOLE INSERT



Brass insert, drilled-out.  
PA: Reinforced polyamide.

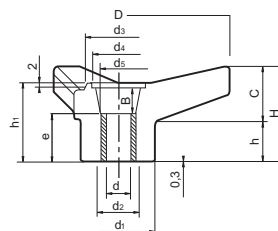

Code	D	H	d	d2	d3	d1	d4	h	h1	C	d5	B	e	Color
470104401	45	21	M6	-	14.5	16	10	10	17.5	11	10	5	12.5	Black
470106401	65	28	M8	-	21	22	15	12	23	16	12	8.5	15.5	Black
470108401	85	36	M10	18	27	30	20	15	30	21	14	12	13.5	Black
470110401	105	45	M12	20	32	35	24	19	37	26	17	16	23	Black
470112401	125	53	M12	26	40	42	27	22.5	44	30.5	24	12	31	Black

## 4701T 3L THREE PRONG KNOB T WITH THREADED STUD

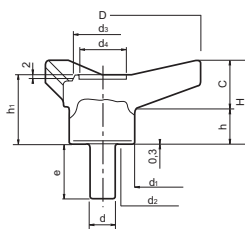

Treated steel stud.  
PA: Reinforced polyamide.

Code	D	H	d	d2	d3	d1	d4	h	h1	C	e	Color
470104501	45	21	M6	-	14.5	16	10	10	17.5	11	25	Black
470106501	65	28	M8	-	21	22	15	12	23	16	30	Black
470108501	85	36	M10	18	27	30	20	15	30	21	40	Black
470110501	105	45	M12	20	32	35	24	19	37	26	50	Black
470112501	125	53	M12	26	40	42	27	22.5	44	30.5	50	Black

## 4702K TMP KNURLED THUMB KNOB K WITH THREADED INSERT

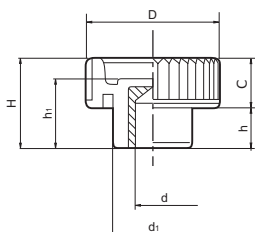

Code	D	H	d	d1	C	h	h1	Color
470221301	21	15	M5	13	8.5	6.5	12.5	Black
470226301	26	18	M6	16	9.5	8.5	15	Black
470233301	33	23	M8	20	12.5	10.5	18	Black
470240301	40	28	M10	25	15.5	12.5	22	Black
470240302	40	28	M12	25	15.5	12.5	22	Black

Female brass insert.  
PA: Polyamide.

## 4702D TMP KNURLED THUMB KNOB D WITH THREADED THROUGH-HOLE INSERT

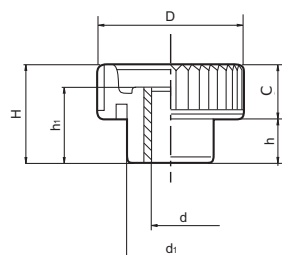

Code	D	H	d	d1	C	h	h1	Color
470215401	15	10	M4	10	5.5	4.5	8.5	Black
470221401	21	15	M5	13	8.5	6.5	12.5	Black
470226401	26	18	M6	16	9.5	8.5	15	Black
470233401	33	23	M8	20	12.5	10.5	18	Black
470240401	40	28	M10	25	15.5	12.5	22	Black
470240402	40	28	M12	25	15.5	12.5	22	Black

Brass insert, drilled-out.  
PA: Polyamide

## 4702D TMP KNURLED THUMB KNOB D WITH THREADED THROUGH-HOLE SS INSERT

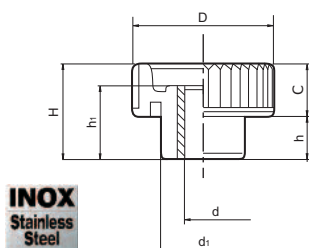

Code	D	H	d	d1	C	h	h1	Color
470215451	15	10	M4	10	5.5	4.5	8.5	Black
470221451	21	15	M5	13	8.5	6.5	12.5	Black
470226451	26	18	M6	16	9.5	8.5	15	Black
470233451	33	23	M8	20	12.5	10.5	18	Black
470240451	40	28	M10	25	15.5	12.5	22	Black
470240452	40	28	M12	25	15.5	12.5	22	Black

Stainless steel (AISI 303)  
insert, drilled-out.  
PA: Polyamide.

## 4702T TMP KNURLED THUMB KNOB T WITH THREADED STUD

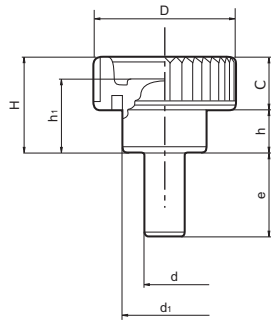

Code	D	H	d	d1	C	h	h1	e	Color
470215501	15	10	M4	10	5.5	4.5	8.5	10	Black
470221501	21	15	M5	13	8.5	6.5	12.5	15	Black
470226501	26	18	M6	16	9.5	8.5	15	20	Black
470233501	33	23	M8	20	12.5	10.5	18	20	Black
470240501	40	28	M10	25	15.5	12.5	22	20	Black
470240502	40	28	M12	25	15.5	12.5	22	30	Black

Treated steel stud.  
PA: Polyamide.

## 4702T TMP KNURLED THUMB KNOB T WITH THREADED SS STUD

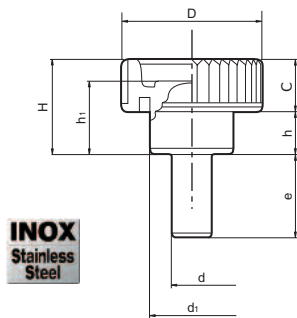

Code	D	H	d	d1	C	h	h1	e	Color
470215551	15	10	M4	10	5.5	4.5	8.5	10	Black
470221551	21	15	M5	13	8.5	6.5	12.5	15	Black
470226551	26	18	M6	16	9.5	8.5	15	20	Black
470233551	33	23	M8	20	12.5	10.5	18	20	Black
470240551	40	28	M10	25	15.5	12.5	22	20	Black
470240552	40	28	M12	25	15.5	12.5	22	30	Black

Stainless steel stud (AISI 303).  
PA: Polyamide.

## 4721K ZN WING NUT K WITH THREADED INSERT

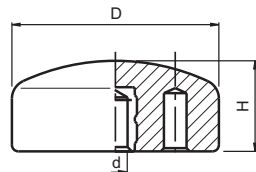

Code	D	H	d	Color
472103300	32	16	M5	Black
472103301	32	16	M6	Black
472103302	32	16	M8	Black
472104300	48	17	M6	Black
472104301	48	17	M8	Black

Female brass insert.  
PA: Polyamide.  
Other thread or plain hole on demand (min. 500 units).  
For different colours, please ask.

## 4721K ZN WING NUT K WITH THREADED SS INSERT

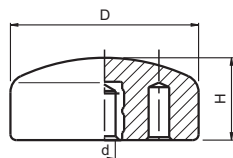
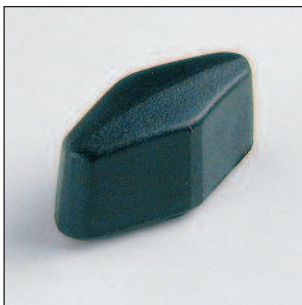

Code	D	H	d	Color
472103310	32	16	M5	Black
472103311	32	16	M6	Black
472103312	32	16	M8	Black
472104310	48	17	M8	Black

Female stainless steel (AISI 303) insert.  
PA: Polyamide.  
Other thread or plain hole on demand (min. 500 units).  
For different colours, please ask.

## 4721T ZN WING NUT T WITH THREADED STUD

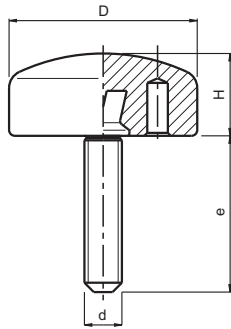

Code	D	H	d	e	Color
472103504	32	16	M6	16	Black
472103501	32	16	M6	25	Black
472103506	32	16	M6	40	Black
472104501	48	17	M8	16	Black
472104502	48	17	M8	25	Black
472104503	48	17	M8	40	Black

Treated steel stud.

PA: Polyamide.

Other stud lengths on demand (min. 500 units).

For different colours, please ask.

## 4721T ZN WING NUT T WITH THREADED SS STUD

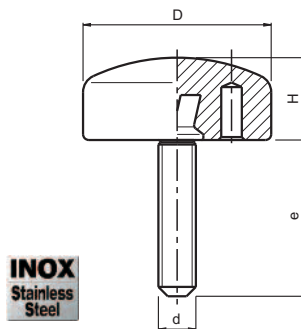

Code	D	H	d	e	Color
472103508	32	16	M6	16	Black
472103509	32	16	M6	25	Black
472104504	48	17	M8	20	Black
472104520	48	17	M8	40	Black

Stainless steel (AISI 303) stud.

PA: Polyamide.

Other stud lengths on demand (min. 500 units).

For different colours, please ask.

## 4723K VZ WING NUT K WITH THREADED INSERT

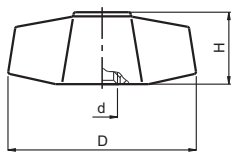

Code	D	H	d	Color
472305301	45	17	M8	Black
472305302	45	17	M10	Black

Female brass insert.

PA: Polyamide.

## 4723D VZ WING NUT D WITH THREADED THROUGH-HOLE INSERT

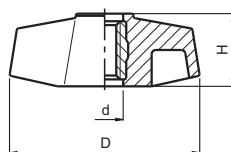

Code	D	H	d	Color
472305402	45	17	M6	Black
472305401	45	17	M8	Black

Zinc-plated steel insert, drilled out.

PA: Polyamide.

## 4723T VZ WING NUT T WITH THREADED STUD



Treated steel stud.  
PA: Polyamide.

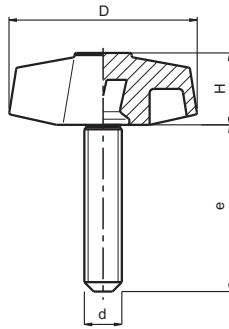

Code	D	H	d	e	Color
472305501	45	17	M8	30	Black
472305512	45	17	M10	30	Black

## 4760K WING NUT TP K WITH THREADED INSERT



- RAL 7035
- RAL 2004
- RAL 9011
- RAL 3000
- RAL 5015
- RAL 1021
- RAL 6024

Brass threaded insert.  
PA: Black reinforced polyamide.  
Caps on the following colours: grey, orange, black, red, blue, yellow and green, similar to the RAL indicated.  
(\* ) 100u. minimum order quantity.

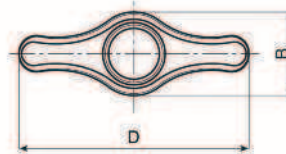
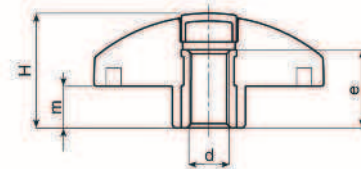

Grey Code	Orange Code	Black Code	Red Code*	Blue Code*	Yellow Code*	Green Code*	D	H	B	d	e	m	Body
476049301	476044301	476041301	476045301	476042301	476043301	476046301	44	22	16	M5	15	8	Black
476049302	476044302	476041302	476045302	476042302	476043302	476046302	44	22	16	M6	15	8	Black
476059302	476054302	476051302	476055302	476052302	476053302	476056302	52	26	19	M6	18	9.5	Black
476059303	476054303	476051303	476055303	476052303	476053303	476056303	52	26	19	M8	18	9.5	Black
476069303	476064303	476061303	476065303	476062303	476063303	476066303	67	32.5	24	M10	18	11	Black
476069304	476064304	476061304	476065304	476062304	476063304	476066304	67	32.5	24	M12	18	11	Black

## 4760D WING NUT TP D WITH THREADED THROUGH-HOLE INSERT



Brass threaded through hole insert.  
PA: Black reinforced polyamide.

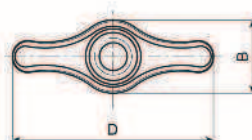
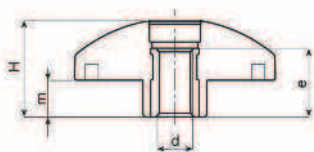

Code	D	H	B	d	e	m	Color
476044401	44	21,5	16	M5	15	8	Black
476044402	44	21,5	16	M6	15	8	Black
476052402	52	25,5	19	M6	18	9,5	Black
476052403	52	25,5	19	M8	18	9,5	Black
476067403	67	32	24	M10	18	11	Black
476067404	67	32	24	M12	18	11	Black

## 4760T WING NUT TP T WITH THREADED STUD



	RAL 7035
	RAL 2004
	RAL 9011
	RAL 3000
	RAL 5015
	RAL 1021
	RAL 6024

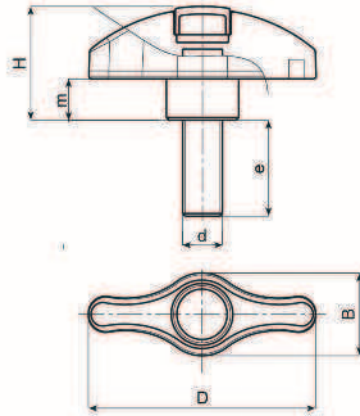

Treated threaded steel stud.  
 PA: Black reinforced polyamide.  
 Caps on the following colours: grey, orange, black, red, blue, yellow and green, similar to the RAL indicated.  
 (\*) 100u. minimum order quantity.

Grey Code	Orange Code	Black Code	Red Code*	Blue Code*	Yellow Code*	Green Code*	D	H	B	d	e	m	Body
476049501	476044501	476041501	476045501	476042501	476043501	476046501	44	22	16	M5	16	8	Black
476049502	476044502	476041502	476045502	476042502	476043502	476046502	44	22	16	M5	25	8	Black
476049503	476044503	476041503	476045503	476042503	476043503	476046503	44	22	16	M6	16	8	Black
476049504	476044504	476041504	476045504	476042504	476043504	476046504	44	22	16	M6	25	8	Black
476059501	476054501	476051501	476055501	476052501	476053501	476056501	52	26	19	M6	40	9.5	Black
476059502	476054502	476051502	476055502	476052502	476053502	476056502	52	26	19	M8	20	9.5	Black
476059503	476054503	476051503	476055503	476052503	476053503	476056503	52	26	19	M8	40	9.5	Black
476069501	476064501	476061501	476065501	476062501	476063501	476066501	67	32.5	24	M10	25	11	Black
476069502	476064502	476061502	476065502	476062502	476063502	476066502	67	32.5	24	M10	50	11	Black
476069503	476064503	476061503	476065503	476062503	476063503	476066503	67	32.5	24	M12	25	11	Black
476069504	476064504	476061504	476065504	476062504	476063504	476066504	67	32.5	24	M12	50	11	Black

## 4725K T HANDLE K WITH THREADED INSERT

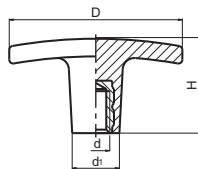

Code	D	H	d	d1	Color
472505301	50	24	M5	14	Black
472506301	60	32	M6	16	Black
472507301	72	32	M8	18	Black

Female brass insert.  
 PA: Polyamide.

## 4725T T HANDLE T WITH THREADED STUD

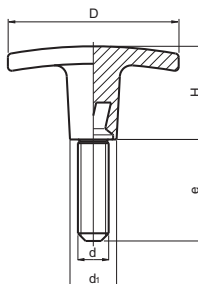

Code	D	H	d	d1	e	Color
472505501	50	24	M5	14	20	Black
472506501	60	32	M6	16	25	Black
472507501	72	32	M8	18	35	Black

Treated steel stud.  
 PA: Polyamide.

## 4758K CROSS KNOB K WITH THREADED SS INSERT

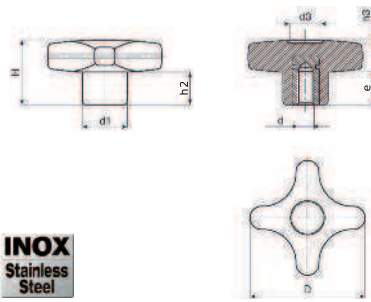

**INOX**  
Stainless  
Steel

Code	D	H	d	e	d1	d3	h2	h3	Color
475803351	32	23	M5	14	15	11	12	1.5	Black
475803352	32	23	M6	9	15	11	12	1.5	Black
475804351	40	24.5	M6	16	16	13	12.5	1.5	Black
475804352	40	24.5	M8	14	16	13	12.5	1.5	Black
475805351	50	29	M8	14	20	14	15	2	Black
475805352	50	29	M10	14	20	14	15	2	Black
475806352	60	34	M12	18	24	18	18.5	2	Black

Stainless steel female threaded insert.  
PA: Polyamide.

## 4758D CROSS KNOB D WITH THREADED THROUGH-HOLE SS INSERT

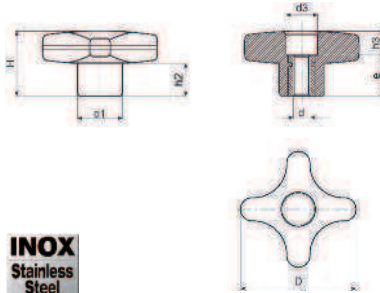

**INOX**  
Stainless  
Steel

Code	D	H	d	e	d1	d3	h2	h3	Color
475803451	32	23	M5	18	15	10	11	5	Black
475803452	32	23	M6	18	15	10	11	5	Black
475804451	40	24.5	M6	18	16	12	12.5	6,5	Black
475804452	40	24.5	M8	18	16	12	12.5	6,5	Black
475805451	50	29	M8	18	20	14	15	11	Black
475805452	50	29	M10	18	20	14	15	11	Black
475806452	60	34	M12	18	24	16	18.5	16	Black

Stainless steel drilled-out  
insert, threaded.  
PA: Polyamide.

## 4758T CROSS KNOB T WITH THREADED SS STUD

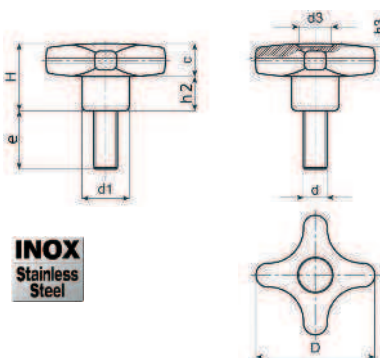

**INOX**  
Stainless  
Steel

Code	D	H	d	e	d1	d3	h2	h3	Color
475803551	32	23	M5	20	15	9	11	1.5	Black
475803553	32	23	M5	40	15	9	11	1.5	Black
475803555	32	23	M6	20	15	9	11	1.5	Black
475803557	32	23	M6	30	15	9	11	1.5	Black
475804551	40	24.5	M6	20	17	12	12.5	1	Black
475804553	40	24.5	M6	40	17	12	12.5	1	Black
475804554	40	24.5	M8	20	17	12	12.5	1	Black
475804556	40	24.5	M8	40	17	12	12.5	1	Black
475805551	50	29	M8	20	20	14.5	15	1.5	Black
475805553	50	29	M8	40	20	14.5	15	1.5	Black
475805554	50	29	M10	20	20	14.5	15	1.5	Black
475805556	50	29	M10	40	20	14.5	15	1.5	Black
475806558	60	34	M12	20	24	18	18.5	1.5	Black
475806560	60	34	M12	40	24	18	18.5	1.5	Black

Threaded stainless steel stud.  
PA: Polyamide.

### 3705F DIN 6336 F CAST IRON UNMACHINED



Fe: Cast iron, sandblasted.

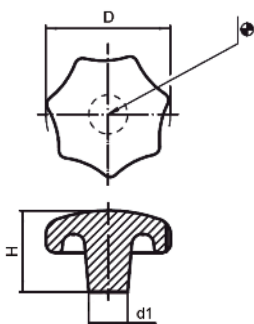

Code	D	H	d1
370503000	32	21	12
370504000	40	26	14
370505000	50	34	18
370506000	63	42	20
370508000	80	52	25

### 3705C DIN 6336 C CAST IRON WITH THREADED BLIND HOLE



Female threaded blind hole.  
Fe: Cast iron, sandblasted.

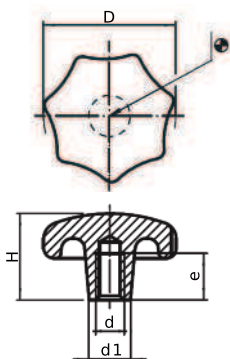

Code	D	H	d1	d	e
370500432	32	20	12	M6	12
370500440	40	25	14	M8	15
370500450	50	32	18	M10	18
370500463	63	40	20	M12	22
370500480	80	50	25	M16	28

### 3705E DIN 6336 E CAST IRON WITH THREADED DRILL OUT HOLE



Female thread drilled out.  
Fe: Cast iron, sandblasted.

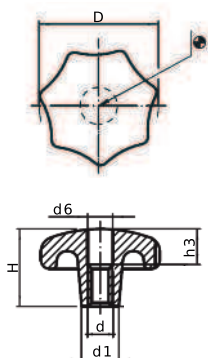

Code	D	H	d1	d6	d	h3
370500332	32	20	12	6,4	M6	10
370500340	40	25	14	8,4	M8	12
370500350	50	32	18	10,5	M10	16
370500363	63	40	20	13,0	M12	20
370500380	80	50	25	17,0	M16	30

### 3707F DIN 6335 F CAST IRON UNMACHINED



Fe: Cast iron, sandblasted.

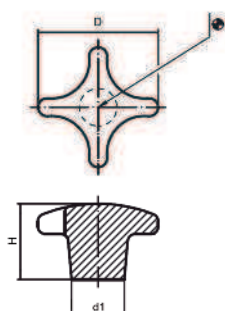

Code	D	H	d1
370703000	32	21	12
370704000	40	26	14
370705000	50	34	18
370706000	63	42	20
370708000	80	52	25
370710000	100	65	32



### 3707C DIN 6335 C CAST IRON WITH THREADED HOLE

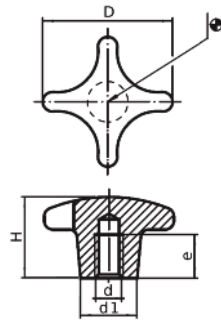

Code	D	H	d1	d	e
370700432	32	20	12	M6	12
370700440	40	25	14	M8	15
370700450	50	32	18	M10	18
370700463	63	40	20	M12	22
370700480	80	50	25	M16	28
370700490	100	63	32	M20	36

Female threaded blind hole.  
Fe: Cast iron, sandblasted.

### 3707E DIN 6335 E CAST IRON WITH THREADED DRILL OUT HOLE

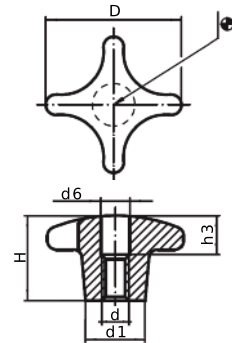

Code	D	H	d1	d6	d	h3
370700332	32	20	12	6,4	M6	10
370700340	40	25	14	8,4	M8	12
370700350	50	32	18	10,5	M10	16
370700363	63	40	20	13,0	M12	20
370700380	80	50	25	17,0	M16	30
370700390	100	63	32	21,0	M20	38

Female thread drilled out.  
Fe: Cast iron, sandblasted.

### 3707F INOX DIN 6335 STAINLESS STEEL UNMACHINED



**INOX**  
Stainless Steel

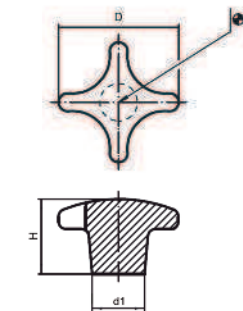

Code	D	H	d1
370710032	32	21	12
370710040	40	26	14
370710050	50	34	18
370710053	63	42	20

SS: Stainless Steel 1.4305,  
dull blasted.

### 3707C INOX DIN 6335 STAINLESS STEEL WITH THREADED HOLE



**INOX**  
Stainless Steel

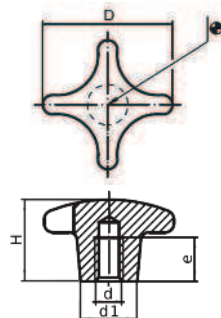

Code	D	H	d1	d	e
370710432	32	20	12	M6	12
370710440	40	25	14	M8	15
370710450	50	32	18	M10	18
370710463	63	40	20	M12	22

Female threaded blind hole.  
SS: Stainless Steel 1.4305,  
dull blasted

**3707E  
INOX**

**DIN 6335 STAINLESS STEEL WITH THREADED DRILL OUT HOLE**



**INOX**  
Stainless  
Steel

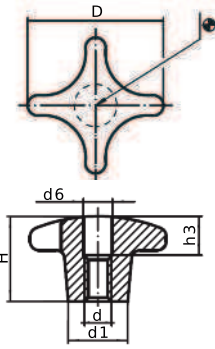

Code	D	H	d1	d6	d	h3
370710332	32	20	12	6,4	M6	10
370710340	40	25	14	8,4	M8	12
370710350	50	32	18	10,5	M10	16
370710363	63	40	20	13,0	M12	20

Female thread drilled out.  
SS: Stainless Steel 1.4305,  
dull blasted.

**3709E**

**DIN 6303 E STEEL WITH THREADED DRILL OUT HOLE**

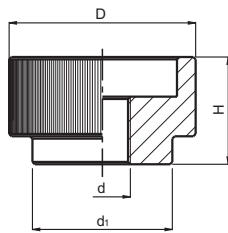

Code	D	H	d	d1	Finish
370920105	20	12	M5	14	Blackened
370924106	24	14	M6	16	Blackened
370930108	30	17	M8	20	Blackened
370936110	36	20	M10	28	Blackened
370940112	40	24	M12	32	Blackened

Female thread, drilled out.  
Fe: Free cutting steel, blackened.

**3711C**

**SOLID SS KNOB C WITH THREADED HOLE**



**INOX**  
Stainless  
Steel

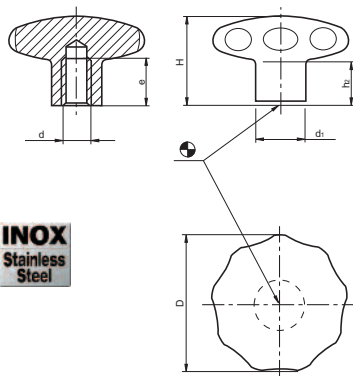

Code	D	H	d1	e	d	h2	Finish
371100645	40	30,5	18	12	M6	15	Dull Blasted
371100646	40	30,5	18	12	M8	15	Dull Blasted
371100655	50	34,0	21	15	M8	17	Dull Blasted
371100656	50	34,0	21	15	M10	17	Dull Blasted
371100665	60	39,0	25	18	M10	18	Dull Blasted
371100666	60	39,0	25	18	M12	18	Dull Blasted

Female thread.  
Inox: Stainless Steel 1.4305.  
For all applications having high  
hygienic requirements.

### 3711E SOLID SS KNOB E WITH THREADED DRILL OUT HOLE

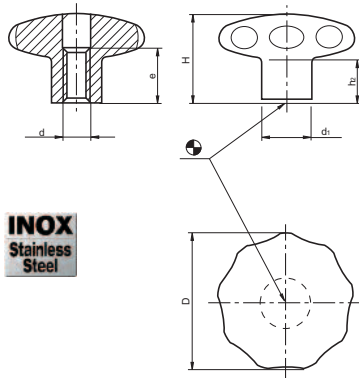
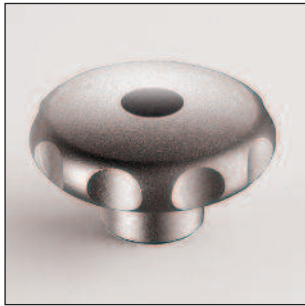

**INOX**  
Stainless Steel

Female thread, drilled-out.  
INOX: Stainless steel 1.4305.  
For all applications having high hygienic requirements.

Code	D	H	d1	e	d	h2	Finish
371100644	40	30,5	18	13	M8	15	Dull Blasted
371100654	50	34,0	21	16	M10	17	Dull Blasted
371100664	60	39,0	25	20	M12	18	Dull Blasted

### 3711G SOLID SS KNOB G WITH SMOOTH HOLE

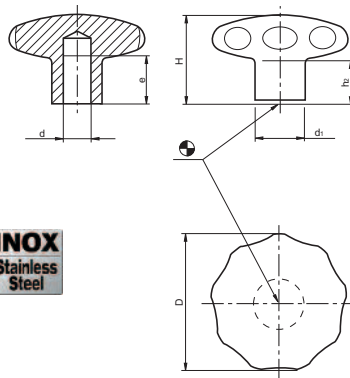

**INOX**  
Stainless Steel

With smooth blind hole.  
INOX: Stainless steel 1.4305.  
For all applications having high hygienic requirements.

Code	D	H	d1	e	d	h2	Finish
371100643	40	30,5	18	12	8	15	Dull Blasted
371100653	50	34,0	21	15	10	17	Dull Blasted
371100663	60	39,0	25	18	12	18	Dull Blasted

### 3711C SS STAR KNOB C WITH THREADED HOLE

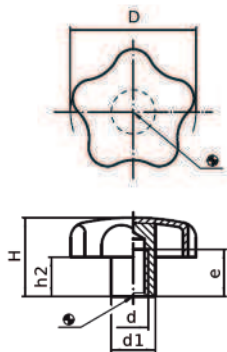

**INOX**  
Stainless Steel

Female thread.  
INOX: Stainless steel 1.4301.  
Sheet-iron drawn with hub welded.

Code	D	H	d1	d	e	h2	Finish
371100440	40	25	14	M8	15	12,5	Dull Blasted
371100450	50	32	18	M10	18	17,5	Dull Blasted
371100460	60	40	20	M12	22	21,0	Dull Blasted

### 3711G SS STAR KNOB G WITH SMOOTH HOLE

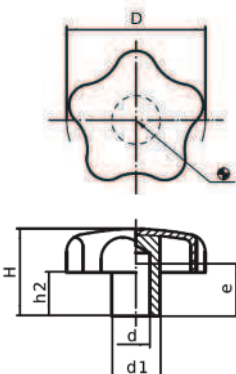

**INOX**  
Stainless Steel

With smooth blind hole (d H7).  
Dimension e shows min. length.  
INOX: Stainless steel 1.4301.  
Sheet-iron drawn with hub welded.

Code	D	H	d1	d	e	h2	Finish
371100240	40	25	14	8	15	12,5	Dull Blasted
371100250	50	32	18	10	18	17,5	Dull Blasted
371100260	60	40	20	12	22	21,0	Dull Blasted

### 3711T SS STAR KNOB T WITH THREADED STUD



**INOX**  
Stainless  
Steel

Threaded stud.  
INOX: Stainless steel 1.4301.  
Sheet-iron drawn with hub welded.

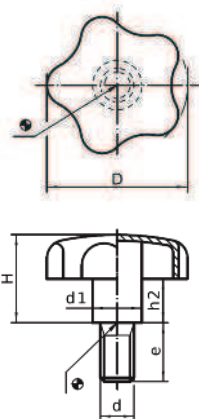

Code	D	H	d1	d	e	h2	Finish
371100140	40	24	14	M8	20	12,0	Dull Blasted
371100144	40	24	14	M8	40	12,0	Dull Blasted
371100150	50	30	18	M10	20	16,5	Dull Blasted
371100154	50	30	18	M10	40	16,5	Dull Blasted
371100160	60	37,5	20	M12	30	20,0	Dull Blasted
371100164	60	37,5	20	M12	50	20,0	Dull Blasted

### 3749C DIN 6335 C ALUMINIUM WITH THREADED HOLE



Female thread.  
AL: Aluminium, polished.

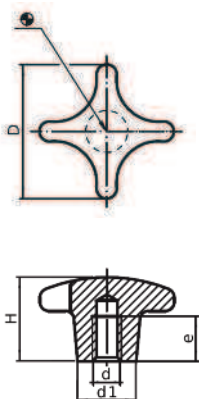

Code	D	H	d1	d	e	Finish
374900840	40	25	14	M8	15	Polished
374900850	50	32	18	M10	18	Polished
374900863	63	40	20	M12	22	Polished
374900880	80	50	25	M16	28	Polished

### 3749E DIN 6335 E ALUMINIUM WITH THREADED DRILL OUT HOLE



Female thread drilled out.  
AL: Aluminium, polished.

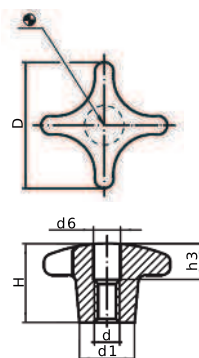

Code	D	H	d1	d	h3	d6	Finish
374900740	40	25	14	M8	12	8,4	Polished
374900750	50	32	18	M10	16	10,5	Polished
374900763	63	40	20	M12	20	13,0	Polished
374900780	80	50	25	M16	30	17,0	Polished

### 3323G DIN 6335 G ALUMINIUM WITH SMOOTH HOLE, POLISHED



d= Smooth blind hole  $\varnothing 6\pm 1$ .  
AL: Aluminium, polished.

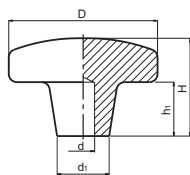

Code	D	H	d1	h1	d	Finish
332304101	40	26	14	13	$6\pm 1$	Polished
332305101	50	34	18	17	$6\pm 1$	Polished
332306101	63	42	20	23	$6\pm 1$	Polished
332308101	80	52	25	29	$6\pm 1$	Polished

### 3323F DIN 6335 F ALUMINIUM UNMACHINED, NOT POLISHED

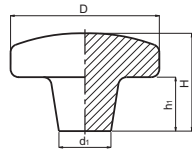
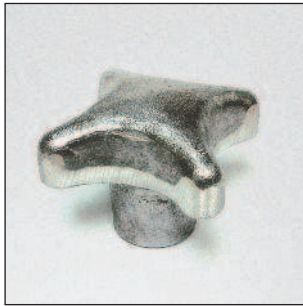

Code	D	H	d1	h1	Finish
332304201	40	25	14	12	Not Polished
332305201	50	32	18	17	Not Polished
332306201	63	40	20	23	Not Polished
332308201	80	50	25	28	Not Polished

AL: Aluminium, not polished.

### 3753C DIN 6336 C ALUMINIUM WITH THREADED HOLE, POLISHED

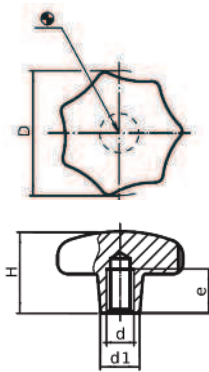

Code	D	H	d1	d	e	Finish
375300840	40	25	14	M8	15	Polished
375300850	50	32	18	M10	18	Polished
375300863	63	40	20	M12	22	Polished
375300880	80	50	25	M16	28	Polished

Female threaded blind hole.  
AL: Aluminium, polished.

### 3753D DIN 6336 D ALUMINIUM WITH THREADED DRILL OUT HOLE

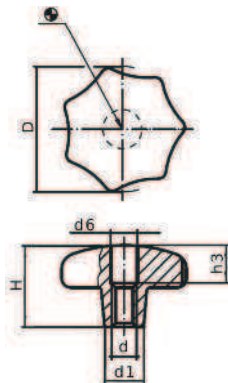

Code	D	H	d1	d6	d	h3	Finish
375300740	40	25	14	8	M8	15	Polished
375300750	50	32	18	10	M10	18	Polished
375300763	63	40	20	13	M12	22	Polished
375300780	80	50	25	17	M16	28	Polished

Female thread drilled out.  
AL: Aluminium, polished.

### 3320G DIN 6336 G ALUMINIUM WITH SMOOTH HOLE, POLISHED

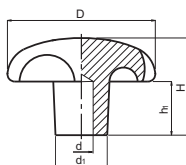

Code	D	H	d1	h1	d	Finish
332004101	40	25	14	12	6±1	Polished
332005101	50	32	18	16	6±1	Polished
332006101	63	40	20	20	6±1	Polished
332008101	80	50	25	25	6±1	Polished

d= Smooth blind hole  $\varnothing 6\pm 1$ .  
AL: Aluminium, polished.

### 3320F DIN 6336 F ALUMINIUM UNMACHINED, NOT POLISHED

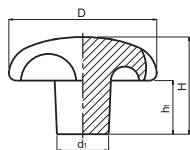

Code	D	H	d1	h1	Finish
332004201	40	25	14	13	Not Polished
332005201	50	32	18	16	Not Polished
332006201	63	40	20	20	Not Polished
332008201	80	50	25	24	Not Polished

AL:Aluminium, not polished.

### 3766T DIN 653 FLAT KNURLED THUMB SCREW

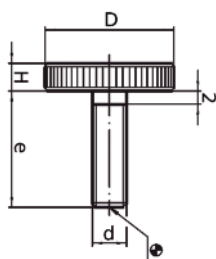

Code	D	H	d	e
376600073	12	2.5	M3	8
376600077	12	2.5	M3	16
376600093	16	3.5	M4	10
376600096	16	3.5	M4	16
376600113	20	4	M5	12
376600117	20	4	M5	20
376600134	24	5	M6	16
376600138	24	5	M6	25
376600154	30	6	M8	20
376600158	30	6	M8	30
376600174	36	8	M10	25
376600180	36	8	M10	40

Threaded stud.  
Fe: Steel quality 5,8 blackened.

### 3766T SS DIN 653 FLAT KNURLED THUMB SCREW



**INOX**  
Stainless  
Steel

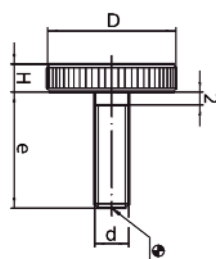

Code	D	H	d	e
376600293	16	3.5	M4	10
376600296	16	3.5	M4	16
376600313	20	4	M5	12
376600317	20	4	M5	20
376600334	24	5	M6	16
376600338	24	5	M6	25
376600354	30	6	M8	20
376600358	30	6	M8	30
376600374	36	8	M10	25
376600380	36	8	M10	40

Threaded stud.  
INOX: Stainless Steel 1.4305,  
dull blasted.

### 3768D DIN 467 FLAT KNURLED NUT

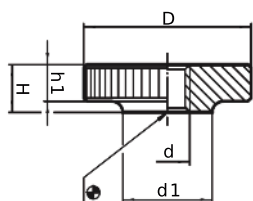

Code	D	H	d	d1	h1
376800030	12	3	M3	6	2.5
376800040	16	4	M4	8	3.5
376800050	20	5	M5	10	4
376800060	24	6	M6	12	5
376800080	30	8	M8	16	6
376800100	36	10	M10	20	8
376800120	40	12	M12	22	10

Female thread drilled out.  
Fe: Steel quality 5 blackened.  
DIN standards do not include  
the item 376800120.

### 3768D SS DIN 467 FLAT KNURLED NUT

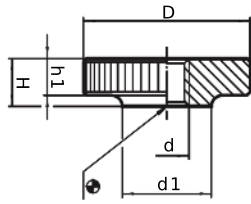

**INOX**  
Stainless  
Steel

Code	D	H	d	d1	h1
376800230	12	3	M3	6	2.5
376800240	16	4	M4	8	3.5
376800250	20	5	M5	10	4
376800260	24	6	M6	12	5
376800280	30	8	M8	16	6
376800300	36	10	M10	20	8

Female thread drilled out.  
INOX: Stainless Steel 1.4305,  
dull blasted.

### 3769T DIN 464 KNURLED THUMB SCREW

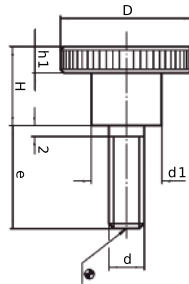

Threaded stud.  
Fe: Steel quality 5,8 blackened.

Code	D	H	d	e	h1	d1
376900076	12	7.5	M3	10	2.5	6
376900079	12	7.5	M3	16	2.5	6
376900095	16	9.5	M4	10	3.5	8
376900098	16	9.5	M4	16	3.5	8
376900115	20	11.5	M5	12	4	10
376900119	20	11.5	M5	20	4	10
376900136	24	15	M6	16	5	12
376900142	24	15	M6	30	5	12
376900154	30	18	M8	16	6	16
376900160	30	18	M8	30	6	16
376900175	36	23	M10	25	8	20
376900181	36	23	M10	40	8	20

### 3769T SS DIN 464 KNURLED THUMB SCREW

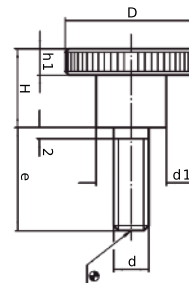

**INOX**  
Stainless  
Steel

Threaded stud.  
INOX: Stainless Steel 1.4305, dull blasted.

Code	D	H	d	e	h1	d1
376900295	16	9.5	M4	10	3.5	8
376900298	16	9.5	M4	16	3.5	8
376900315	20	11.5	M5	12	4	10
376900319	20	11.5	M5	20	4	10
376900336	24	15	M6	16	5	12
376900342	24	15	M6	30	5	12
376900354	30	18	M8	16	6	16
376900360	30	18	M8	30	6	16

### 3772D DIN 466 KNURLED NUT

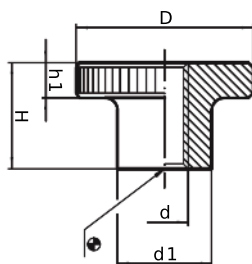

Female thread drilled out.  
Fe: Steel quality 5 blackened.  
DIN standards do not include  
the item 377200120.

Code	D	H	d	d1	h1
377200030	12	7.5	M3	6	2.5
377200040	16	9.5	M4	8	3.5
377200050	20	11.5	M5	10	4
377200060	24	15	M6	12	5
377200080	30	18	M8	16	6
377200100	36	23	M10	20	8
377200120	40	25	M12	22	10

## 3772D SS DIN 466 KNURLED NUT



**INOX**  
Stainless  
Steel

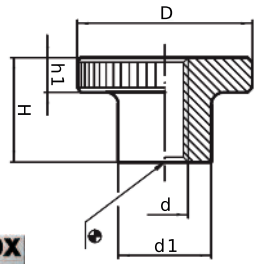

Code	D	H	d	d1	h1
377200240	16	9.5	M4	8	3.5
377200250	20	11.5	M5	10	4
377200260	24	15	M6	12	5
377200280	30	18	M8	16	6
377200300	36	23	M10	20	8

Female thread drilled out.  
INOX: Stainless Steel 1.4305, dull blasted.

## 3882 KNOB TK STEEL, KNURLED

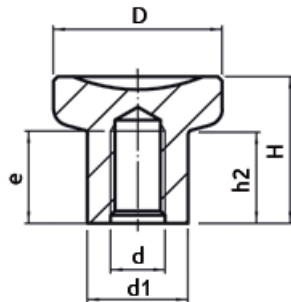

Code	D	H	h2	d	e	d1
388200023	21	18	10,5	M5	10	12,5
388200025	25	22,5	14	M6	12	14,5
388200028	31	27	17	M8	15	18,5
388200029	31	27	17	M10	17	18,5

Female threaded blind hole.  
Fe: Steel, blackened.

## 3882 KNOB TK STAINLESS STEEL



**INOX**  
Stainless  
Steel

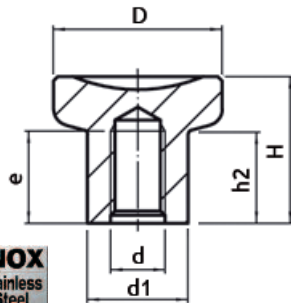

Code	D	H	h2	d	e	d1
388200103	21	18	10,5	M5	10	12,5
388200105	25	22,5	14	M6	12	14,5
388200108	31	27	17	M8	15	18,5
388200109	31	27	17	M10	17	18,5

Female threaded blind hole.  
SS: Stainless Steel 1.4305, dull blasted.