

Handwheels

Page		Page		Page	
39		42		47	
39		42		47	
39		42		48	
39		43		48	
40		43			
40		44			
40		45			
40		45			
41		46			
41		46			
41		46			
41		47			

1131S FOUR SPOKE S HANDWHEEL WITH SMOOTH HOLE HUB

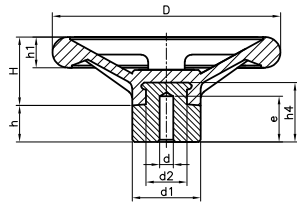

Code	D	H	d	e	d2	h4	d1	h	h1	Color
113110601	100	31	5,25	20	18	26	30	16	13,5	Black
113112601	125	37	8	25	28	32	40	22	14	Black
113115601	150	50	10	30	30	55	50	30	18	Black
113117601	175	51	10	30	30	55	50	30	20	Black
113120601	200	70	10	30	30	55	50	30	26	Black
113130601	300	98	10	30	34	60	60	18	30	Black

Treated steel insert.
PF: Black Duroplast FS 31 DIN 7708.

1131Sa FOUR SPOKE Sa HANDWHEEL WITH SMOOTH HOLE HUB AND THREADED SEAT FOR HANDLE

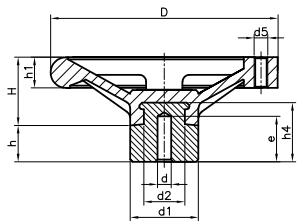

Code	D	H	d	e	d2	h4	d1	h	h1	d5	Color
113110651	100	31	5,25	20	18	26	30	16	13,5	M6	Black
113112651	125	37	8	25	28	32	40	22	14	M6	Black
113115651	150	50	10	30	30	55	50	30	18	M8	Black
113117651	175	51	10	30	30	55	50	30	20	M10	Black
113120651	200	70	10	30	30	55	50	30	26	M12	Black

Treated steel insert.
Threaded hole for fixed and giratory handles codes 1141, 1136 and 1137.
PF: Black Duroplast FS 31 DIN 7708.

1132H SOLID H HANDWHEEL WITH SMOOTH HOLE INSERT

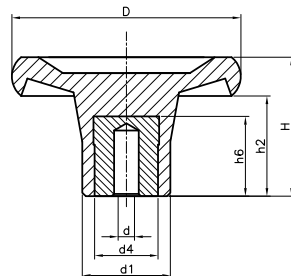

Code	D	H	d	d1	h2	h6	d4	Color
113204301	45	26,5	5,25	20	17	17	14	Black
113206302	65	31	5,25	25	20	22	18	Black
113208302	80	38	5,25	30	25	22	18	Black

Treated steel insert.
PF: Black Duroplast FS 31 DIN 7708.

1132P SOLID P HANDWHEEL WITH SQUARE HOLE

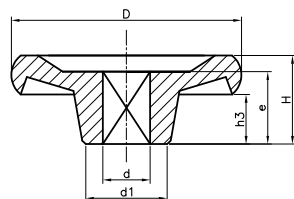

Code	D	H	d	e	h3	d1	Color
113206401	65	20	10x10	15	11	26	Black
113208401	80	21	10x10	15	9	34	Black
113210401	100	23	10x10	15	5	44	Black
113212401	125	31	12x12	21	10	40	Black
113215401	150	32	12x12	21	7	50	Black

Moulded square hole.
PF: Black Duroplast FS 31 DIN 7708.

1132T SOLID T HANDWHEEL WITH THREADED STUD

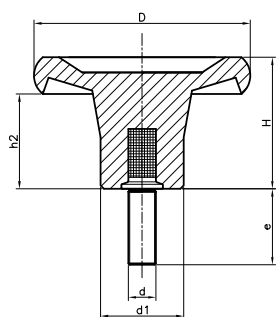

Code	D	H	d	e	d1	h2	Color
113204501	45	26	M8	27	20	16	Black
113206506	65	30	M10	33	25	19	Black
113208502	80	37	M12	40	30	24	Black

Treated threaded steel stud.
PF: Black Duroplast FS 31 DIN 7708.

1132S SOLID S HANDWHEEL WITH SMOOTH HOLE HUB

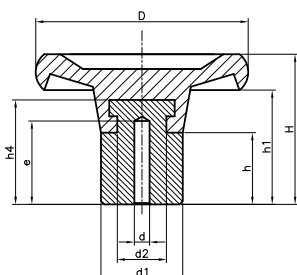

Code	D	H	d	e	d2	h4	d1	h	h1	Color
113204601	45	33	5,25	20	11	20	20	24	21	Black
113206601	65	39	5,25	22	19	29	25	24	28	Black
113208601	80	43	5,25	20	18	26	30	24	31	Black
113210601	100	52	8	25	28	32	40	25	34	Black
113212601	125	64	8	25	28	32	40	25	43	Black
113215601	150	82	10	30	35	50	50	30	57	Black
113217601	175	84	10	30	35	50	50	30	64	Black
113220601	200	86	10	30	35	50	50	30	64	Black

Treated steel insert.
PF: Black Duroplast FS 31 DIN 7708.

1132Sa SOLID Sa HANDWHEEL WITH SMOOTH HOLE HUB AND THREADED SEAT FOR HANDLE

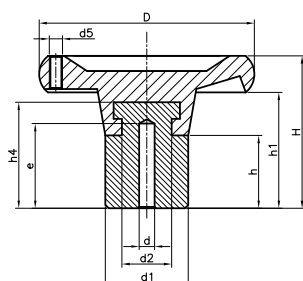

Code	D	H	d	e	d2	h4	d1	h	h1	d5	Color
113210651	100	52	8	25	28	32	40	25	34	M6	Black
113212651	125	64	8	25	28	32	40	25	43	M8	Black
113215651	150	82	10	30	35	50	50	30	57	M10	Black
113217651	175	84	10	30	35	50	50	30	64	M10	Black
113220651	200	86	10	30	35	50	50	30	64	M12	Black

Treated steel insert.
Threaded hole for fixed and giratory handles codes 1141, 1136 and 1137.
PF: Black Duroplast FS 31 DIN 7708.

1173 Q HANDWHEEL WITH SQUARE HOLE

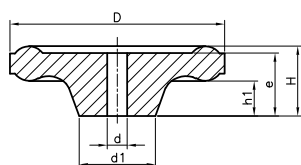

Code	D	H	d	e	d1	h1	Color
117335201	35	15	5x5	13	13	9	Black
117350201	50	22	7x7	17	21	10	Black
117361201	61	20	7x7	18	21	10	Black
117371201	71	24	7x7	22	27	12	Black
117371202	71	24	8x8	22	27	12	Black

Square hole.
PF: Black Duroplast FS 31 DIN 7708.

1183H SIX H HANDWHEEL WITH SMOOTH HOLE INSERT

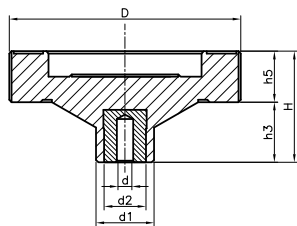

Code	D	H	d	d1	d2	h5	h3	Color
118306301	65	36	5,25	25	18	15	22	Black
118308301	80	38	5,25	25	18	16	22	Black

Treated steel insert.
PF: Black Duroplast FS 31 DIN 7708.

1183T SIX T HANDWHEEL WITH THREADED STUD

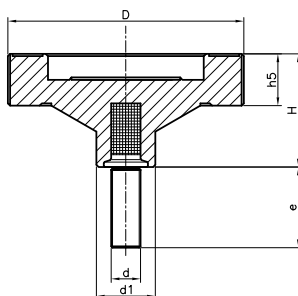

Code	D	H	d	e	d1	h5	Color
118306501	65	37	M10	33	25	15	Black
118308502	80	38	M12	40	25	16	Black

Treated threaded steel stud.
PF: Black Duroplast FS 31 DIN 7708.

1183S SIX S HANDWHEEL WITH SMOOTH HOLE HUB

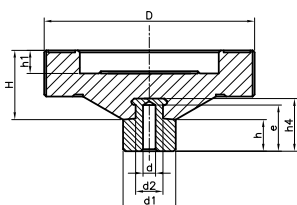
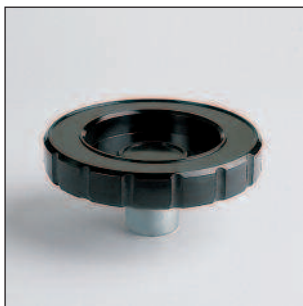

Code	D	H	d	d1	d2	e	h1	h4	h	Color
118306601	65	30	5,25	25	19	15	10	29	15	Black
118308601	80	30	5,25	25	19	15	10	29	15	Black
118310601	100	33	5,25	25	19	15	11	29	15	Black
118313601	130	33	5,25	30	18	20	11	26	16	Black

Treated steel insert.
PF: Black Duroplast FS 31 DIN 7708.

1183Sa SIX Sa HANDWHEEL WITH SMOOTH HOLE HUB AND THREADED SEAT FOR HANDLE

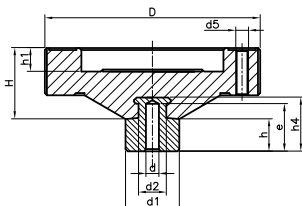

Code	D	H	d	d1	d2	d5	e	h1	h4	h	Color
118310651	100	33	5,25	25	19	M6	15	11	29	15	Black
118313651	130	33	5,25	30	18	M8	20	11	26	16	Black

Treated steel insert.
Threaded hole for fixed and revolving handle codes 1141, 1136 and 1137.
PF: Black Duroplast FS 31 DIN 7708.

1184D* VALVE D* HANDWHEEL WITH SMOOTH HOLE INSERT

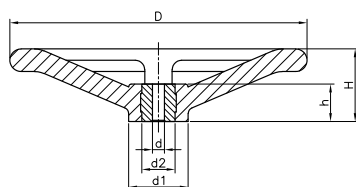

Treated steel insert.
PF: Black Duroplast FS 31 DIN 7708.

Code	D	H	d1	d	d2	h	Color
118412401	128	38	30	10	20	21	Black
118415401	150	61	34	10	25	31	Black
118416401	160	50	35	10	25	31	Black
118420401	200	54	48	10	25	31	Black
118425401	250	61	50	10	25	31	Black

3301G* DIN 950-A4 ALUMINIUM G*

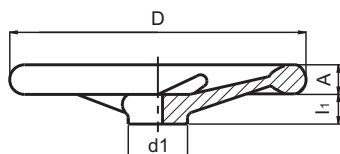

AL: Aluminium, polished.
Central Bore Ø 5 to 10 mm.
Available with keyway. Please ask.

Code	D	d1	l1	A	Nº spokes	Finish
330108101	80	24	16	14	3	Polished
330110101	100	26	17	15	3	Polished
330112101	125	29	18	16	3	Polished
330114101	140	30	19	17	3	Polished
330116101	160	37	20	18	3	Polished
330118101	180	38	22	20	3	Polished
330120101	200	42	24	22	3	Polished
330122101	225	44	26	24	5	Polished
330125101	250	53	28	26	5	Polished
330128101	280	56	30	26	5	Polished
330131101	315	57	33	28	5	Polished
330136101	360	70	35	30	5	Polished
330140101	400	70	38	32	5	Polished
330150101	500	79	45	34	5	Polished
330156101	560	102	50	36	5	Polished

3301G*a DIN 950-A4 ALUMINIUM G*a

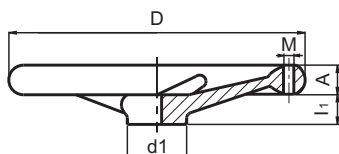

AL: Aluminium, polished.
Central Bore Ø 5 to 10 mm.
M: Thread for handle, recommended codes:
3310, 3311, 3312 or 3313.
Available with keyway. Please ask.

Code	D	d1	l1	A	Nº spokes	M	Finish
330108151	80	24	16	14	3	M6	Polished
330110151	100	26	17	15	3	M6	Polished
330112151	125	29	18	16	3	M8	Polished
330114151	140	30	19	17	3	M8	Polished
330116151	160	37	20	18	3	M10	Polished
330118151	180	38	22	20	3	M10	Polished
330120151	200	42	24	22	3	M10	Polished
330122151	225	44	26	24	5	M10	Polished
330125151	250	53	28	26	5	M12	Polished
330128151	280	56	30	26	5	M12	Polished
330131151	315	57	33	28	5	M12	Polished
330136151	360	70	35	30	5	M12	Polished
330140151	400	70	38	32	5	M16	Polished
330150151	500	79	45	34	5	M16	Polished
330156151	560	102	50	36	5	M16	Polished

3304G* HR-RI ALUMINIUM HANDWHEEL G*

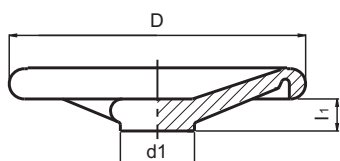

AL: Aluminium, not polished.
Central bore Ø 5 to 10 mm. Rim slightly polished.
On the surface is written: OUVERT - FERME, OPEN - CLOSED.

Code	D	d1	l1	Nº spokes	Finish
330410101	100	27	17	3	Not Polished
330412101	125	39	17	3	Not Polished
330414101	140	37	18	3	Not Polished
330416101	160	38	20	3	Not Polished
330420101	200	38	24	3	Not Polished
330422101	225	55	26	5	Not Polished
330425101	250	54	28	5	Not Polished
330431101	315	60	30	5	Not Polished
330440101	400	70	27	5	Not Polished
330450101	500	80	27	5	Not Polished

3305G* ZPK 2 SPOKE ALUMINIUM HANDWHEEL G*

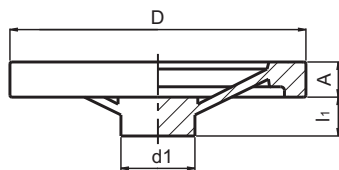

Code	D	d1	l1	A	Finish
330508101	80	20	16	14	Polished
330510101	100	25	17	15	Polished
330512101	125	35.5	18	17	Polished
330514101	140	37	19	19	Polished
330516101	160	39	20	18	Polished
330518101	180	41	22	21	Polished
330520101	200	47	24	22	Polished
330525101	250	50	28	25	Polished
330532101	315	57	33	30	Polished

Al: Aluminium, polished.
 Central bore Ø 5 to 10 mm.
 Available with keyway. Please ask.

3305G*a ZPK 2 SPOKE ALUMINIUM HANDWHEEL G*a WITH SEAT FOR HANDLE

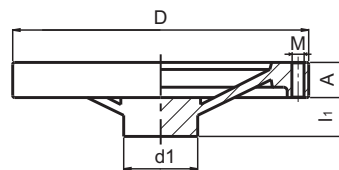

Code	D	d1	l1	A	M	Finish
330508151	80	20	16	14	M6	Polished
330510151	100	25	17	15	M6	Polished
330512151	125	35.5	18	17	M8	Polished
330514151	140	37	19	19	M8	Polished
330516151	160	39	20	18	M10	Polished
330518151	180	41	22	21	M10	Polished
330520151	200	47	24	22	M10	Polished
330525151	250	50	28	25	M12	Polished
330532151	315	57	33	30	M12	Polished

Al: Aluminium, polished.
 Central bore Ø 5 to 10 mm.
 M= thread for handle, recommended codes:
 1136, 1137, 3314, 3316 or 3738.
 Available with keyway. Please ask.

3308G* SGF-GH SOLID ALUMINIUM HANDWHEEL G*

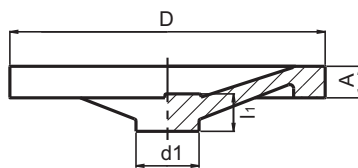

Code	D	d1	l1	A	Finish
330808101	80	26	16	16	Polished
330810101	100	30	17	18	Polished
330812101	125	30	18	21	Polished
330814101	140	35	19	22	Polished
330816101	160	42	20	24	Polished
330818101	180	43	22	25	Polished
330820101	200	50	24	26	Polished
330822101	225	52	26	27	Polished
330825101	250	50	29	31	Polished
330828101	280	56	31	30	Polished
330831101	315	60	34	33	Polished

Al: Aluminium, polished.
 Central bore Ø 5 to 10 mm.
 Available with keyway. Please ask.

3308G* a SGF-GH SOLID ALUMINIUM HANDWHEEL G* a WITH SEAT FOR HANDLE

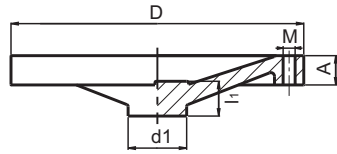

Code	D	d1	l1	A	M	Finish
330808151	80	26	16	16	M6	Polished
330810151	100	30	17	18	M6	Polished
330812151	125	30	18	21	M8	Polished
330814151	140	35	19	22	M8	Polished
330816151	160	42	20	24	M10	Polished
330818151	180	43	22	25	M10	Polished
330820151	200	50	24	26	M10	Polished
330822151	225	52	26	27	M12	Polished
330825151	250	50	29	31	M12	Polished
330828151	280	56	31	30	M12	Polished
330831151	315	60	34	33	M12	Polished

AL: Aluminium, polished.
 Central bore \varnothing 5 to 10 mm.
 M= thread for handle, recommended codes:
 1136, 1137, 3314, 3316 or 3738.
 Available with keyway. Please ask.

3701G* DIN 950-A4 CAST IRON G* a

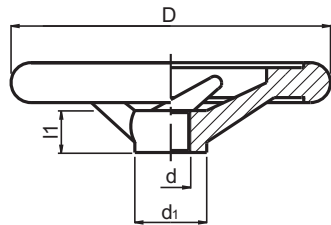

Code	D	d1	l1	d	Nº spokes
370108101	80	24	16	10	3
370110101	100	26	17	10	3
370112101	125	28	18	12	3
370114101	140	30	19	14	3
370116101	160	32	20	14	3
370120101	200	38	24	18	3
370125101	250	45	28	22	5
370131101	315	53	33	26	5
370140101	400	65	38	30	5

Central crossing bore.
 FE: Grey cast iron, clearly debured. Hub machined.
 Available with keyway. Please ask.

3701G* a DIN 950-A4 CAST IRON G* a WITH SEAT FOR HANDLE

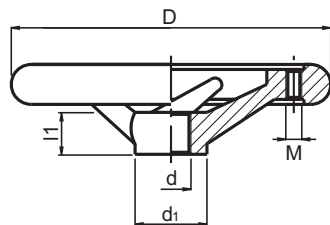

Code	D	d1	l1	d	M	Nº spokes
370108151	80	24	16	10	M6	3
370110151	100	26	17	10	M6	3
370112151	125	28	18	12	M8	3
370114151	140	30	19	14	M8	3
370116151	160	32	20	14	M10	3
370120151	200	38	24	18	M10	3
370125151	250	45	28	22	M12	5
370131151	315	53	33	26	M12	5
370140151	400	65	38	30	M16	5

Central crossing bore.
 FE: Grey cast iron, clearly debured. Hub machined.
 d5= Thread for handle, recommended codes:
 3710 or 3712.
 Available with keyway. Please ask.

3701G* INOX STAINLESS STEEL HANDWHEELS

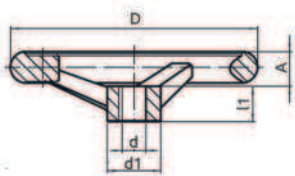

Code	D	d1	l1	d	A	Nº spokes
370110201	100	25,5	17	10	14,5	3
370112201	125	27,0	18	12	15,8	3
370114201	140	29,0	19	14	17,0	3
370116201	160	31,0	20	14	17,5	3
370120201	200	37,0	24	18	20,0	3

Handwheel similar to DIN 950.
SS: Stainless Steel A4.
Hub machined and rim polished.
Available with keyway. Please ask.

INOX
Stainless
Steel

3701G* m INOX STAINLESS STEEL HANDWHEELS WITH HANDLE

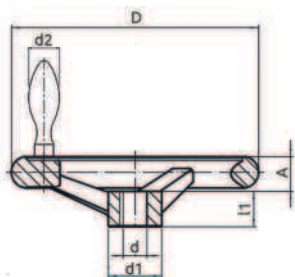

Code	D	d1	l1	d	A	d2	Nº spokes
370110281	100	25,5	17	10	14,5	16	3
370112281	125	27,0	18	12	15,8	20	3
370114281	140	29,0	19	14	17,0	20	3
370116281	160	31,0	20	14	17,5	25	3
370120281	200	37,0	24	18	20,0	25	3

Handwheel similar to DIN 950, with fix handle.
SS: Stainless Steel A4.
Hub machined and rim polished.
Available with keyway. Please ask.

INOX
Stainless
Steel

4713 3 ARM HANDWHEEL H WITH SMOOTH THROUGH HOLE INSERT

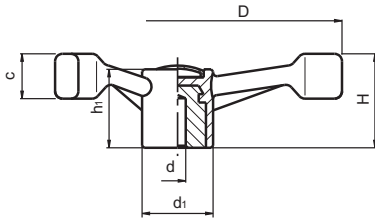

Code	D	H	h1	d1	d	dm	c	Color	Cap
471314301	137	45	39	38	5	22	23	Black	Grey
471318301	177	56	43	38	5	22	24	Black	Grey
471322301	221	61	46	38	5	22	28	Black	Grey

Zinc plated steel right through bored bush.
 PA: Polyamide black.
 Central cap colour grey RAL 7035.
 dm=maximum diameter to mechanize central bush.
 On demand we can supply central cap in diferent colours.
 For min. quantities we can supply central bush with keyway or with a thread.

4730H FOUR ARM HANDWHEEL H WITH SMOOTH THROUGH HOLE INSERT



Code	D	H	h1	h4	h2	h3	e	d1	d	dm	d2	C	A	Color	Cap
473031301	308	66	45,5	3	46	7,5	38	83	8 H11	26	35,5	20	45,5	Black	Grey

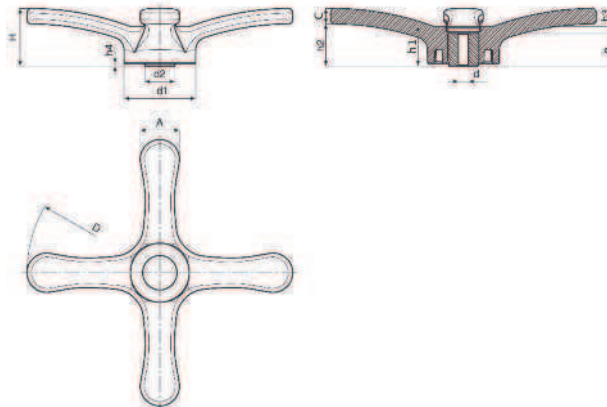

Zinc plated steel right through bored bush.
 PA: Black Polyamide.
 Central cap colour: Grey RAL 7035.
 dm= maximum diameter to mechanize central bush.
 On demand we can supply central cap in different colours.
 For min. quantities we can supply central bush with keyway

4731D* HANDWHEEL 2R D* WITH SMOOTH THROUGH HOLE INSERT

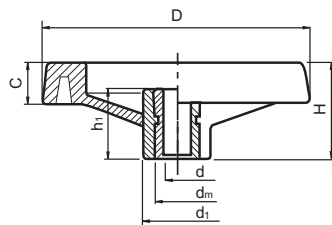

Code	D	H	d1	C	h1	d	dm	Color	Cap
473108301	80	34	24	14	26	5	12	Black	Grey
473110301	100	42	28	16	33	5	16	Black	Grey
473113301	130	50	32	20	36	5	18	Black	Grey
473116301	160	56	40	24	40	5	22	Black	Grey
473120301	200	61	51	28	40	5	22	Black	Grey
473125301	250	71	56	32	47	5	28	Black	Grey
473135301	350	80	68	37	50	5	30	Black	Grey

Zinc plated steel through bored bush.
 PA: Black reinforced polyamide with central cap in grey (RAL 7035).
 dm=maximum diameter to mechanize central bush.

4731D*a HANDWHEEL 2R D*a WITH SMOOTH THROUGH HOLE INSERT AND SEAT FOR HANDLE

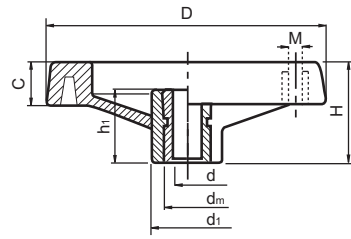

Code	D	H	M	d1	C	h1	d	dm	Color	Cap
473108701	80	34	M6	24	14	26	5	12	Black	Grey
473110701	100	42	M6	28	16	33	5	16	Black	Grey
473113701	130	50	M8	32	20	36	5	18	Black	Grey
473116701	160	56	M8	40	24	40	5	22	Black	Grey
473120701	200	61	M8	51	28	40	5	22	Black	Grey
473125701	250	71	M10	56	32	47	5	28	Black	Grey
473135701	350	80	M10	68	37	50	5	30	Black	Grey

Zinc plated steel right through bored bush.
 PA: Black reinforced polyamide with central cap in grey (RAL 7035).
 dm=maximum diameter to mechanize central bush.
 M= Thread for handle, recommended handles 4733, 4734 & 4735 (not included with the handwheel).

4731D*mp HANDWHEEL 2R D*mp WITH SMOOTH THROUGH HOLE INSERT AND FOLD AWAY REVOLVING HANDLE

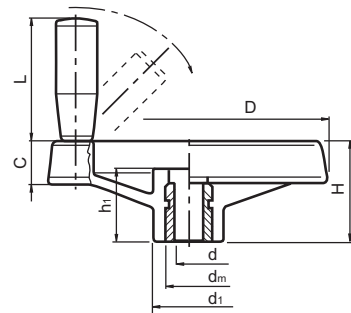

Code	D	H	d1	C	h1	d	dm	L	Color	Cap
473113801	130	52	31	23	33.5	5	18	58	Black	Grey
473116801	160	55	40	24	35	5	22	70	Black	Grey
473135801	350	80	67	37	50	5	30	90	Black	Grey

Zinc plated steel right through bored bush and mechanism for the handle made of blackened steel.
 Fold away revolving handle mounted on the handwheel.
 PA: Black reinforced polyamide with central cap in grey (RAL 7035).
 dm=maximum diameter to mechanize central bush.

4732D* SOLID CONTROL HANDWHEEL D* WITH SMOOTH THROUGH HOLE INSERT

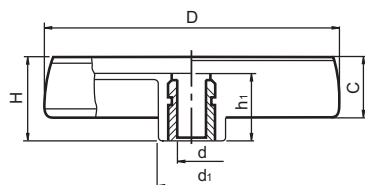

Code	D	H	d1	C	h1	d	dm	Color	Cap
473208301	80	33	24	17	29	5	12	Black	Grey
473210301	100	39	30	21	34	5	16	Black	Grey
473212301	125	44	36	24	37	5	18	Black	Grey
473215301	150	53	38	29	43	5	22	Black	Grey
473217301	175	56	40	32	46	5	22	Black	Grey
473220301	200	59	44	34	49	5	28	Black	Grey
473225301	250	68	59	39	58	5	28	Black	Grey

Zinc plated steel right through bore bush.
 PA: Black reinforced polyamide with central cap in grey (RAL 7035).
 dm=maximum diameter to mechanize central bush.

4732D* a SOLID CONTROL HANDWHEEL D* a WITH SMOOTH THROUGH HOLE INSERT AND SEAT FOR HANDLE

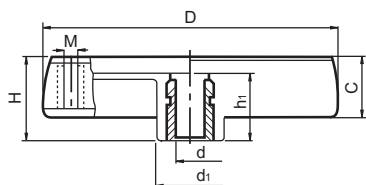

Code	D	H	d1	C	h1	d	M	dm	Color	Cap
473208701	80	33	24	17	29	5	M6	12	Black	Grey
473210701	100	39	30	21	34	5	M6	16	Black	Grey
473212701	125	44	36	24	37	5	M8	18	Black	Grey
473215701	150	53	38	29	43	5	M10	22	Black	Grey
473217701	175	56	40	32	46	5	M10	22	Black	Grey
473220701	200	59	44	34	49	5	M10	28	Black	Grey
473225701	250	68	59	39	58	5	M10	28	Black	Grey

Zinc plated steel right through bored bush and lateral brass insert for the handle.

PA: Black reinforced thermoplastic with central cap in grey (RAL 7035).

Recommended handles 4733, 4735 & 4734 (not included with the handwheel).

dm=maximum diameter to mecanize central bush.

4732D* mp SOLID CONTROL HANDWHEEL WITH FOLD AWAY REVOLVING HANDLE D* mp WITH SMOOTH THROUGH HOLE

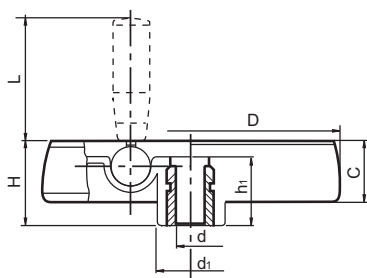

Code	D	H	d1	C	h1	d	dm	L	Color	Cap
473208781	80	33	24	18	29	5	12	38	Black	Grey
473210781	100	42	30	24	36	5	16	48	Black	Grey
473212781	125	47	36	27	40	5	18	58	Black	Grey
473215781	150	53	38	28	44	5	22	60	Black	Grey
473217781	175	58	40	33	48	5	28	80	Black	Grey
473220781	200	63	44	38	53	5	28	90	Black	Grey
473225781	250	67	60	38	58	5	28	90	Black	Grey

Zinc plated steel right through bored bush and mechanism for the handle made of blackened steel.

Fold away revolving handle mounted on the handwheel.

PA: Black reinforced polyamide with central cap in grey (RAL 7035).

dm=maximum diameter to mechanize central bush.