

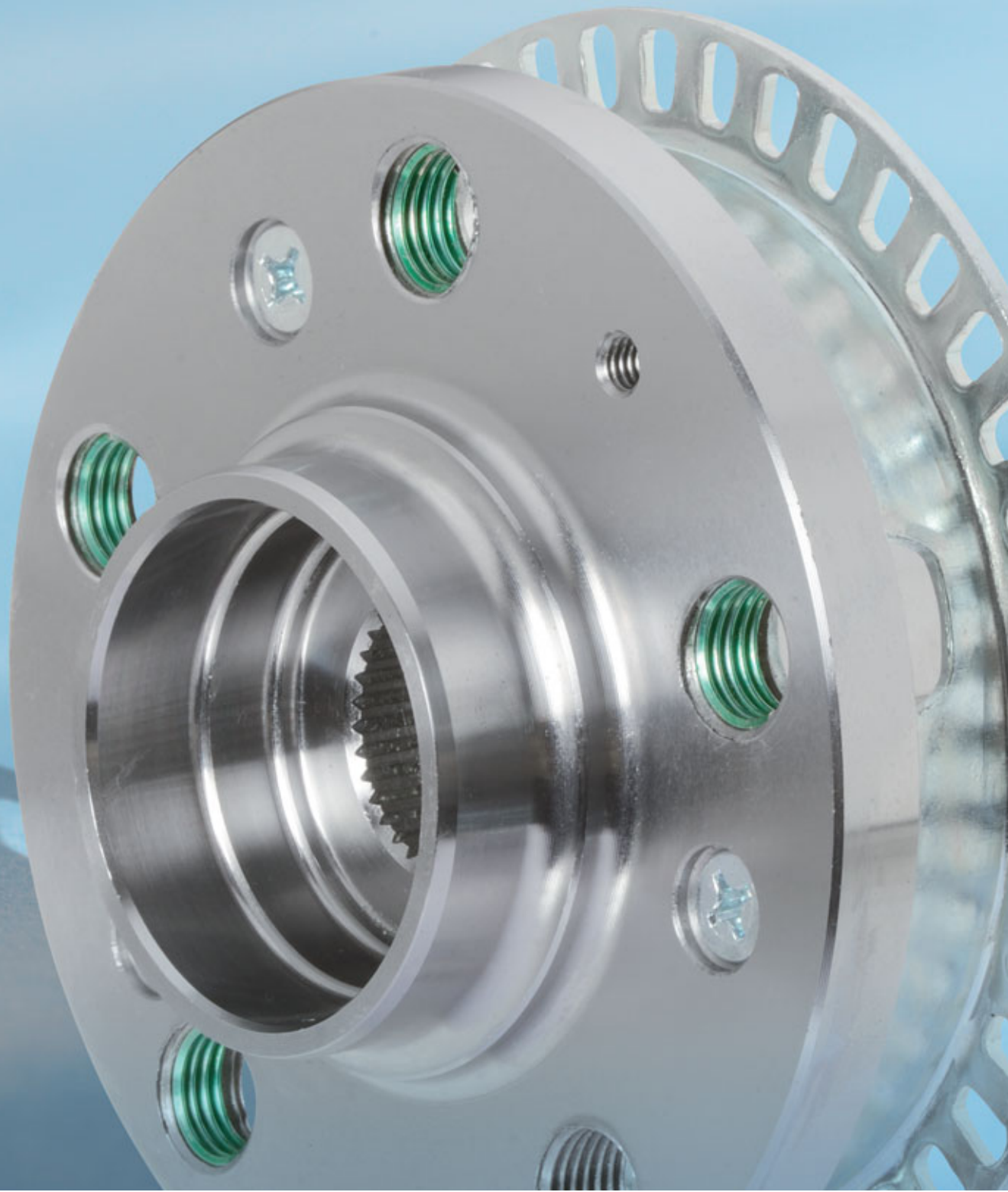

HELICOIL® Plus

Thread technology for
high-strength fastenings
– metric threads

Kel
BULGARIA
BÖLLHOFF



System modules – the fastener

	Page
Technology	05
Designs	06
A close look at the advantages	08
Modular system	10
Materials	12
Design guidelines	13
Fields of application	14
Installation	16
Technical data and item numbers	18

System modules – the tool

The thread	28
Thread tolerances and tapped hole	29
All taps at a glance	30
Manual taps	32
Machine taps	34
Combined drilling and tapping tools	36
Machine forming taps	36
Threaded plug gauges	38
Repair kits and repair range kits	39

Installation

Installation mandrels	42
Installation tools	
Battery installation tools	44
Electrical installation tools	45
Pneumatic installation tools	46
Accessories	52
Automatic installation	53
Manual installation tools	54
Tang break-off and extraction tools	55



Large picture (left): Application example

HELICOIL® thread inserts



Can you imagine a world without screws? Even today, the screw is the most widely used fastening element for detachable joints. Optimised tightening methods and high-strength screws allow constant improvement. Considerably higher forces can be transmitted so that the dimension or total number of required screws can be reduced. However, only highly sustainable nut threads permit high-strength screw joints. This is where our HELICOIL® thread technology is used.

Your advantages – an overview:

- High thread loading
- Increased quality and value
- Wear-resistant, low and constant thread friction
- Strong
- Corrosion and temperature resistant
- Cost-effective
- Tight fit
- Screw locking

HELICOIL® thread inserts

Structural component – thread reinforcement and repair

HELICOIL® is thread reinforcement and repair.

Threads are reinforced whenever low-strength materials (e.g. aluminium, aluminium-magnesium alloys and fibre-reinforced plastics) are used. The nut thread is wear-resistant even in cases of frequent use. HELICOIL® allows miniaturisation and lightweight construction for the development of production parts. The HELICOIL® thread insert has been tried and tested for more than 60 years and has become a widely used structural component.

Worldwide, HELICOIL® thread inserts are approved for economical and lasting repair of damaged or worn out threads.

Apart from repair of valuable individual components, parts used in large-scale production which have been rejected due to faults during thread production can be reintegrated into the production process.

Technology

Thanks to continuous optimisation, the HELICOIL® Plus is now much easier to install. “Plus” refers to the special start of the thread, compared to the HELICOIL® Classic. The thread insert is a wire with rhombic profile formed into an elastic spiral. It is positioned and screwed in like a screw. To screw in the thread insert, all you need is an installation mandrel with thread dimensions similar to a tap of the same nominal diameter. However, existing tools of the commonly used design can still be used for installation. Thanks to the considerably wider range of tools to be used for installation, installation times are up to 20 % shorter than for previous methods.

If through-hole threads are required, after installation, the tang can be broken off at the notch (predetermined breaking point).

HELICOIL® Plus produces high-strength threads transferring forces from flank to flank into the holding thread. It is a highly reliable system for which German and international industrial property rights have been filed. HELICOIL® Plus are thread inserts produced according to consistent material and quality specifications and meet the requirements of national standardisation as well as aeronautical and military standards. Apart from that, leading large-scale users base their manufacturing standards on this system.



Defective thread



Repaired thread



R_m = min. tensile strength 1400 N/mm² (1 N/mm² equals 1 MPa)
 HV = Vickers hardness 425 HV 0.2 min.
 R_z = roughness depth approx. 2.5 µm
 μ_G = reduced thread friction, results in increased preload-force FV at constant tightening torque
 τ_t = reduced torsion stress in the screw shank

HELICOIL® Plus Free Running*



Every thread of the thread insert with precision-formed, rhombic profile is Free Running. The result is an internal thread true to gauge that can be used from both ends. The dimensional stability of the ISO thread complies with DIN 13 6H as well as for special requirements with 4H and meets the demands on international standard specifications. The advantages of the HELICOIL® Plus system are particularly apparent with respect to processing and tools and result in shorter cycle times.

HELICOIL® Plus Screwlock*



This thread insert has an additional screw-locking area. One or several polygonal-shaped threads clamp the flanks of the installed screw. The elastically resilient frictional locking results in prevailing torques similar to the specifications of ISO 2320. These screw locking torques meet the demands of technical delivery terms regarding international standard specifications. However, the prevailing torques can also be adjusted as required for the corresponding application, e.g. for securing of setting screws. HELICOIL® Plus Screwlock can only be used with screws of higher property classes (8.8 and higher). Common lubricants according to the manufacturers' recommendations should be used for highly alloyed screws. The advantages of the HELICOIL® Plus system are particularly apparent with respect to processing and tools and result in shorter cycle times.

HELICOIL® Classic Free Running*



Every thread of the thread insert with precision-formed, rhombic profile is Free Running. The result is an internal thread true to gauge that can be used from both ends. The dimensional stability of the ISO thread complies with DIN 13 6H as well as for special requirements with 4H and meets the demands on international standard specifications.

HELICOIL® Classic Screwlock*



This thread insert has an additional screw-locking area. One or several polygonal-shaped threads clamp the flanks of the installed screw. The elastically resilient frictional locking results in prevailing torques similar to the specifications of ISO 2320. These screw locking torques meet the demands of technical delivery terms regarding international standard specifications. However, the prevailing torques can also be adjusted as required for the corresponding application, e.g. for securing of setting screws. HELICOIL® Classic Screwlock can only be used with screws of higher property classes (8.8 and higher). Common lubricants according to the manufacturers' recommendations should be used for highly alloyed screws.

* Comply with DIN 8140 standard. For further standards, see page 12.

HELICOIL® Tangfree Free Running**



You do not need a tang to install these thread inserts. Therefore, tang break and removal are not required. Combined with the matching installation tools, the current innovation status in the HELICOIL® technology is a perfect addition to the HELICOIL® product family.

Simply order the separate catalogue No 0150.

HELICOIL® Tangfree Screwlock**



HELICOIL® Tangfree Screwlock has the same advantages as HELICOIL® Tangfree. In addition, there is a screw-locking area. The screw is locked by one or several polygonal-shaped threads clamping the flanks of the screwed in screw. The elastically resilient frictional locking results in prevailing torques similar to the specifications of ISO 2320. These screw locking torques meet the demands of technical delivery terms regarding international standard specifications. HELICOIL® Tangfree Screwlock can only be used with screws of higher property classes (8.8 and higher). Common lubricants according to the manufacturers' recommendations shall be used for highly alloyed screws. This thread insert is widely used in the aviation industry.

Simply order the separate catalogue No 0150.

HELICOIL® Locknuts



HELICOIL® locknuts consist of a nut body and an integrated HELICOIL® Plus Screwlock thread insert. One or several polygonal-shaped threads clamp the flanks of the screwed in screw resulting in elastically resilient frictional locking. The achieved prevailing torques are similar to the specifications of ISO and meet the demands of technical delivery terms regarding international standard specifications. Moreover, they can also be adjusted as required for the corresponding application. HELICOIL® nuts are available in different materials.

Simply order the separate catalogue No 0560.

RIVKLE® Aero



RIVKLE® Aero combines a high-strength stainless steel blind rivet nut and a HELICOIL® Screwlock. These two perfectly matching fasteners provide considerable benefits for screwed connections on thin-walled components with high mechanical requirements. Due to the polygonal-shaped thread of the HELICOIL® Screwlock thread insert, there is a locking effect on the flanks of the screw or bolt to be screwed in.

As a result, there is a highly elastically resilient frictional locking so that the screw is locked to prevent self-unscrewing.

Simply order the separate catalogue No 2307.

** Comply with standards NAS 1130 and NAS 0276. For further standards, see page 12.

HELICOIL® thread inserts – a close look at the advantages

Wear resistance

HELICOIL® Plus thread inserts are made of austenitic chrome-nickel steel (minimum tensile strength 1,400 N/mm²). The high surface quality of the rolled thread ensures a high-strength, wear-resistant thread with an extremely small and constant thread friction torque. Therefore, a higher, constant preload-force is achieved for repeated cycles at the same tightening torque. The utilisation of the yield point of high-strength screws is improved. Torsion stress is considerably reduced. Compared to tapped threads, the surface roughness of the HELICOIL® Plus is reduced by 90%.

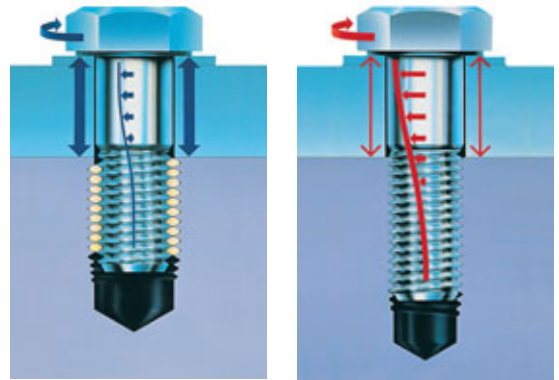

Strength

The elastic properties of the HELICOIL® Plus thread insert allow a uniform load and stress distribution. An optimum flank contact is achieved. Variable pitches and angles are compensated for over the entire length of the thread insert. Force transmission from bolt to nut thread is optimised. The quality of the screw joint is considerably increased – for static as well as dynamic operating loads.

Due to the improved distribution of the preload-force, the fatigue strength of dynamically loaded screws is increased. This is why the HELICOIL® is also suitable for use in threads in high-strength materials, e.g. steel or cast iron alloys.

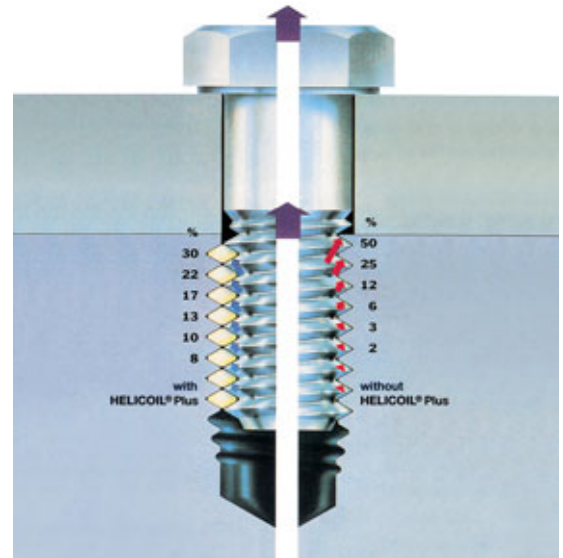

Corrosion and temperature resistance

The standard material of the HELICOIL® Plus prevents seizing of screws under environmental influences. HELICOIL® Plus thread inserts of nickel-based materials are available for thermally highly stressed screw joints. Elasticity and spring force remain constant. For materials particularly susceptible to corrosion, such as magnesium, the HELICOIL® Plus made of hard-coated high-strength aluminium is used. This prevents contact corrosion caused by galvanic action.



Tight fit

When not installed, the outside diameter of the HELICOIL® Plus exceeds the receiving thread by a defined amount. In combination with the high spring force of the material, this difference in dimension results in radial expansion and therefore in the tight and clearance-free fit in the nut thread. Additional locking elements or adhesive – as are common for fixed bushes – are therefore obsolete.

If you use impact wrenches, please contact us. We will be happy to help you.

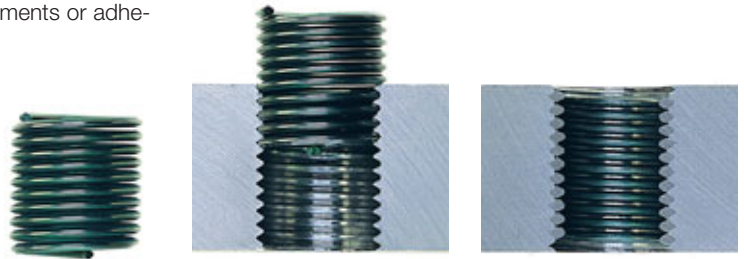

Screw locking

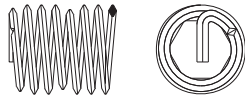

Thread technology and the polygonal-shaped thread of the HELICOIL® Plus Screwlock lead to a high degree of frictional locking and thus prevents the screw unscrewing and its losing. Additional locking of the joint with split pins, wires or washers is not required. Costs are reduced and installation is easier.

Friction

Thread friction and its scatter range can be reduced if a HELICOIL® is used. The dispersion range can be restricted. (For example: If the thread friction value μ_G of a property class 10.9 carbon steel screw, screwed into a tapped nut thread ranges between 0.12 and 0.18, the μ_G values range between 0.11 and 0.13 if a coil thread insert is used.) For a torque-controlled screw tightening application, the screw preload-force can be adjusted more precisely and the yield point of the screw utilised more efficiently. Simultaneously, the preload force is increased during screw breakage due to reduced torsional stress.

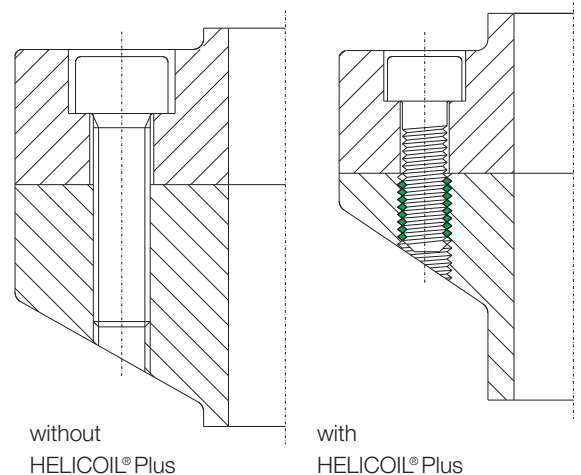

Downsizing

Engineers can choose almost any material. The HELICOIL® Plus corresponds to today's trend toward lightweight construction (e.g. aluminium and magnesium) because this method of thread reinforcement combines minimum space requirements and high strength. High-strength screws are therefore also perfectly suitable for low-shear materials. A reduced number of joints and smaller screw sizes save material, installation space and weight – at high fatigue strength. These are definite advantages of the HELICOIL® system.



HELICOIL® modular system

The HELICOIL® has been tried and tested for more than 60 years and has become a renowned structural component. There is a solution to almost every task related to this thread technology.

Thread types	Metric coarse thread DIN ISO 13 1	Metric fine thread DIN ISO 13 (T02-T11)	Pipe thread DIN EN ISO 228/1 G	UNC thread NASM 21209
Designs	 HELICOIL® Plus Free Running	 HELICOIL® Plus Screwlock	 HELICOIL® Tangfree	
Materials	Stainless steel A2 material No 1.4301	Stainless steel A4 material No 1.4571	Bronze material No 2.1020.34	Inconel X 750 material No 2.4669
Surfaces	Bright		Tin-plated G100 / G300	Dry film lubricated

HELICOIL® further catalogues



HELICOIL® Plus
Imperial thread inserts for metals
Catalogue No 0101

<http://www.boellhoff.de/en/helicoil-plus-imperial>



HELICOIL® Tangfree
The Tangfree coil thread insert for a high-strength thread
Catalogue No 0150

<http://www.boellhoff.de/en/helicoil-tangfree>





Thread types



Designs



Materials



Surfaces

Not all combinations are viable.

HELICOIL® Plus
Repairing of damaged threads
Catalogue No 0180
<http://www.boellhoff.de/en/thread-repair>

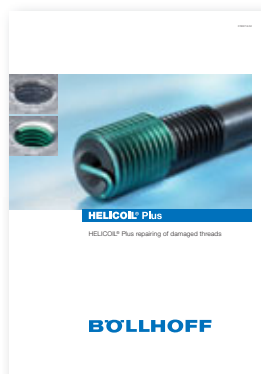

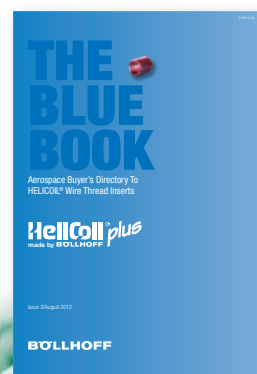

THE BLUE BOOK
Aerospace Buyer's Directory to HELICOIL® Wire Thread Inserts
Catalogue No 0130
<http://www.boellhoff.de/the-blue-book>



Materials

The overview table shows the most common materials with specifications.

 Materials ①	 Temperature resistance	 Minimum tensile strength at room temperature	Examples of use
Stainless steel A 2 X5 CrNi 18 10 material No 1.4301	low temperature –196°C short-term 425°C long-term 315°C	1400 N/mm ² *	<ul style="list-style-type: none"> Standard applications for all property classes and materials ③ General lightweight construction e.g. of aluminium, magnesium or aluminium alloys ②
Stainless steel A 4 X6 CrNiMoTi 17 12 2 ④ material No 1.4571	low temperature –196°C short-term 425°C long-term 315°C	1400 N/mm ² *	<ul style="list-style-type: none"> Increased corrosion protection Highly alloyed CrNi steel screws ③ Low thread friction General lightweight construction Sea water/chlorine-containing water
Bronze CuSN 6 material No 2.1020.34	short-term 300°C long-term 250°C	900 N/mm ² *	<ul style="list-style-type: none"> Copper workpieces Moving threads CrNi steel screws
Inconel X 750 NiCr 15 Fe 7 TiAl ④ material No 2.4669	short-term 750°C long-term 550°C	1150 N/mm ² *	<ul style="list-style-type: none"> Thermal load in combination with corrosion protection Aerospace technology Aeroplane engines Turbochargers
Nimonic 90 NiCr 20 Co 18 Ti material No 2.4632	short-term 900°C long-term 600°C		
Aluminium AlZnMgCu 1.5 ④ material No 3.4365	short-term 170°C long-term 150°C	500 N/mm ² *	<ul style="list-style-type: none"> Magnesium workpieces Vehicle technology Lightweight construction

① Further materials and surfaces on request.

② If magnesium alloys are used outdoors, we recommend special measures for corrosion protection.

③ If CrNi screws are used, you should use a suitable coating or standard lubricant.

④ Delivery on request.

Note: Data only apply to uncoloured HELICOIL® Plus.

Up to M 5, the applied colour is temperature-resistant from –18°C to +200°C.

From M 6, the applied colour is temperature-resistant from –5°C to +120°C (+150°C short-term).

*1 N/mm² equals 1 MPa

Thread types

Thread	HELICOIL® Plus Free Running		HELICOIL® Plus Screwlock		Page
	Nominal diameters	Nominal lengths	Nominal diameters	Nominal lengths	
Metric ISO thread coarse thread	M 2 to M 42*	0.5 d to 3 d	M 2 to M 39	0.75 d to 3 d ⑤	18–23
Metric ISO thread fine thread	M 8 x 1 to M 39 x 3*	0.5 d to 3 d	M 8 x 1 to M 64 x 4	0.75 d to 3 d	

⑤ Length 3 d only from M 3.

*Further sizes available.

HELICOIL® Plus thread inserts comply with diverse requirements and standards from general and aerospace industries, such as DIN 8140, DIN 65536, LN 9039 and LN 9499. Further standards (e.g. MS or EN standards) on request.

Prevailing torques

Guide values for prevailing torques according to ISO 2320 Valid for coarse threads and fine thread Values in Nm for property class 8											
Thread	M 3	M 4	M 5	M 6	M 8	M 10	M 12	M 14	M 16	M 18	M 20
1 st cycle-on, max.	0.43	0.90	1.60	3.00	6.00	10.5	15.5	24.0	32.0	42.0	54.0
1 st cycle-off, min.	0.12	0.18	0.29	0.45	0.85	1.5	2.3	3.3	4.5	6.0	7.5
5 th cycle-off, min.	0.08	0.12	0.20	0.30	0.60	1.0	1.6	2.3	3.0	4.2	5.3

Clamping torques for other metric threads on request.

Determination of nominal length

Guide values to determine the minimum length of the HELICOIL® Plus thread insert depending on parent material and screw property class, valid for 20°C.

Strength of parent material	Screw property class									
	3.6 4.6	4.8 5.6	5.8 6.6	6.8 6.9	8.8	9.8	10.9	12.9	14.9	
Tensile strength R_m (N/mm ²)*										
to 100	1.5 d	1.5 d	2 d	2.5 d	3 d	3 d	–	–	–	
> 100 – 150	1.5 d	1.5 d	2 d	2 d	2.5 d	2.5 d	2.5 d	2.5 d	3 d	
> 150 – 200	1 d	1.5 d	1.5 d	1.5 d	2 d	2 d	2 d	2.5 d	2.5 d	
> 200 – 250	1 d	1 d	1.5 d	1.5 d	1.5 d	1.5 d	2 d	2.5 d	2.5 d	
> 250 – 300	1 d	1 d	1 d	1 d	1.5 d	1.5 d	1.5 d	2 d	2 d	
> 300 – 350	1 d	1 d	1 d	1 d	1 d	1.5 d	1.5 d	1.5 d	2 d	
> 350 – 400	1 d	1 d	1 d	1 d	1 d	1 d	1.5 d	1.5 d	1.5 d	
> 400	1 d	1 d	1 d	1 d	1 d	1 d	1.5 d	1.5 d	1.5 d	

The table of values to determine the nominal length applies to aluminium as well as to materials with a ratio from $\frac{\text{shear stress}}{\text{tensile stress}} = 0.6$ to 0.7 . Some iron cast alloys have a ratio ranging from $\frac{\text{shear stress}}{\text{tensile stress}} = 0.8$ to 1.4 . (source: VDI 2230)

For these guide values, the screw is the weaker joint member.

Lengths can be shorter than the recommended nominal lengths if tests confirm this.

Intermediate lengths are also available.

Temperature limits for validity: aluminium alloys $T_{max} = 300^\circ\text{C}$, magnesium alloys $T_{max} = 100^\circ\text{C}$.

For the design of screw joints under thermal stress, the changes of temperature-dependent material parameters must be taken into account.

* 1 N/mm² equals 1 MPa

Minimum wall thickness (related to outside diameter of the HELICOIL® receiving thread)

The minimum wall thickness mainly depends on individual operating data. These define material strength and length of thread engagement. The indicated guide value formulas apply to aluminium, cast and wrought alloys and a length of thread engagement of the HELICOIL® Plus of 1.5 d.

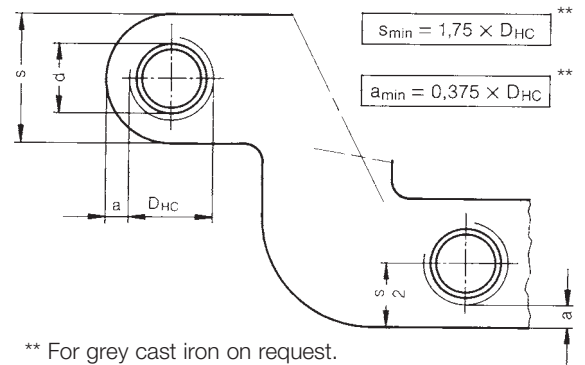

- d = nominal Ø
- D_{HC} = outside Ø of the receiving thread
- a = residual wall thickness

Diagrammatic representation with the example of M 10 x 15:

HELICOIL® Plus thread insert installed

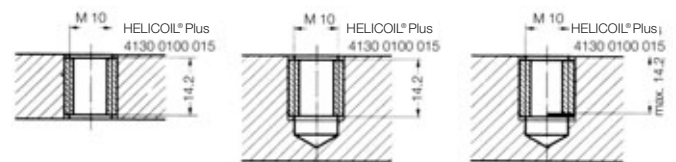

HELICOIL® Plus thread insert installed, with screw

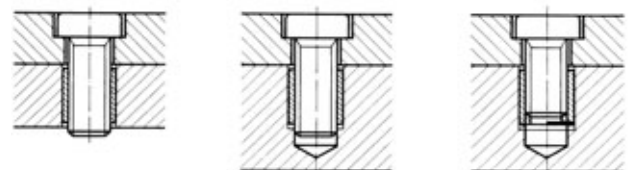

Free CAD download

We offer a free CAD download service. Download 3-D models of Böllhoff products and directly integrate them into your designs.

www.boellhoff.de/en/cad

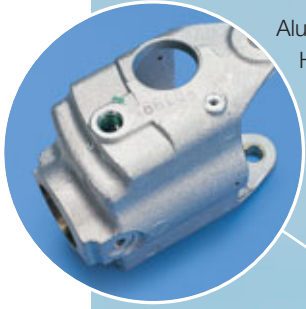

Aluminium steering gear casing
HELICOIL® Plus
Free Running
M 14 x 1.5 x 14

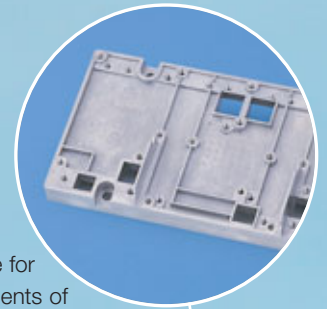

Mounting plate for
electronic components of
die-cast aluminium



High-temperature application with
Inconel HELICOIL® insert, silver plated



Cast aluminium fitting for
car roof rails with HELICOIL® Plus
Screwlock M 6 x 6



Cast aluminium cage
protection of flush-mounted
lamp
HELICOIL® Plus
Free Running M 8 x 12



Automotive



Aerospace industry



Rail carriages



White goods



Plastics



Metal construction

Fields of application for HELICOIL® Plus thread inserts

- Gear box housing of magnesium alloys
- Thread reinforcement for oil drain plugs
- Exhaust systems
- Satellite technology
- Aeroplane engines
- Repeated installations
- Maintenance and repair
- Lamps
- Electrical appliances
- Hammer drills
- Printing presses

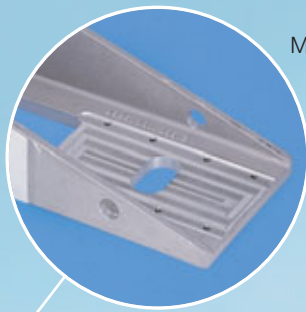

Magnesium bracket (G-ALSi9 Mg)
HELICOIL® Plus
Free Running M 8 x 12



Oil drain hole of an aluminium car oil sump
Thread reinforcement with HELICOIL® Plus
Free Running M 14 x 1.5 x 14



Housing for aluminium electronic components
HELICOIL® Plus Screwlock

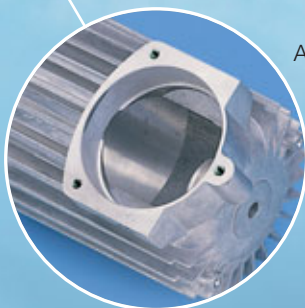

Aluminium cast alloy housing
Flange with HELICOIL® Plus
Screwlock M 5 x 10



Agricultural machinery



Construction machinery

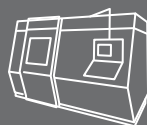

Mechanical engineering



Wind power



Electronic devices

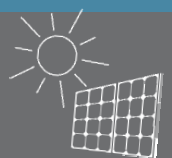

Solar

HELICOIL® Plus installation

HELICOIL® Plus thread inserts can be easily and economically installed because there are only a few basic rules to observe. There is a broad range of installation tools for efficient installation – for individual applications as well as for large-scale production. Installation phases are as follows:

Drilling

Common twist drills are used.

Notes on diameter and tapped hole depth are given on pages 18 to 23.

Prior to tapping, counter-bore 90° and deburr. Outside diameter of **countersink = $D_{HC} + 0.1$ mm.**



Tapping

To tap the HELICOIL® Plus holding thread, system-dependent original HELICOIL® taps must be used.

Recommendations for suitable manual and machine taps are given on pages 30 to 37. The trueness to gauge of the holding thread must be checked with HELICOIL® thread plug limit gauges (see page 38).



Form tapping

Today, chipless production of internal threads with forming taps is an efficient production method for many materials. This also applies to the HELICOIL® Plus (see bottom of page 36).

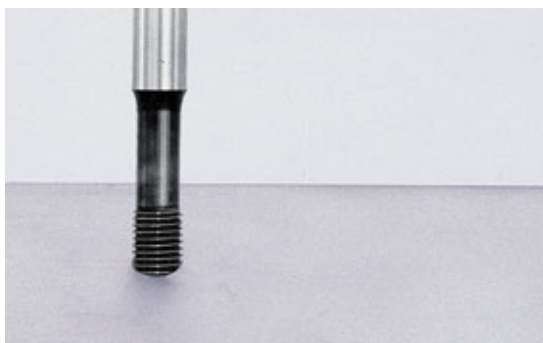

Insertion of thread insert

Manual as well as machine installation tools or automatic installation machines can be used for installation. The HELICOIL® Plus thread insert is screwed onto the installation mandrel with the tang down (a), inserted into the leader cartridge (b) or placed on the fly-over tool (c). Then, the tool is placed over the tapped hole.

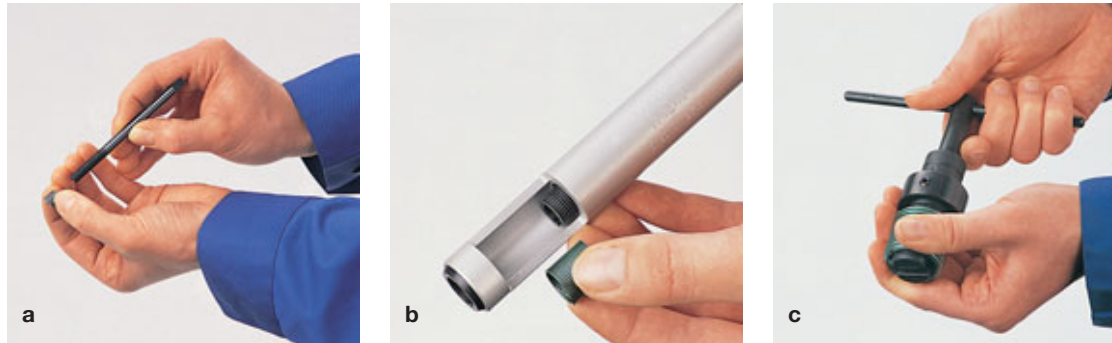

Installation

By turning the threaded mandrel (d), the mandrel (e) or the fly-over tool (f), respectively, manually or triggering the drive, the thread insert is screwed in. It must be installed at least 0.25 P below the surface (see page 17 b).

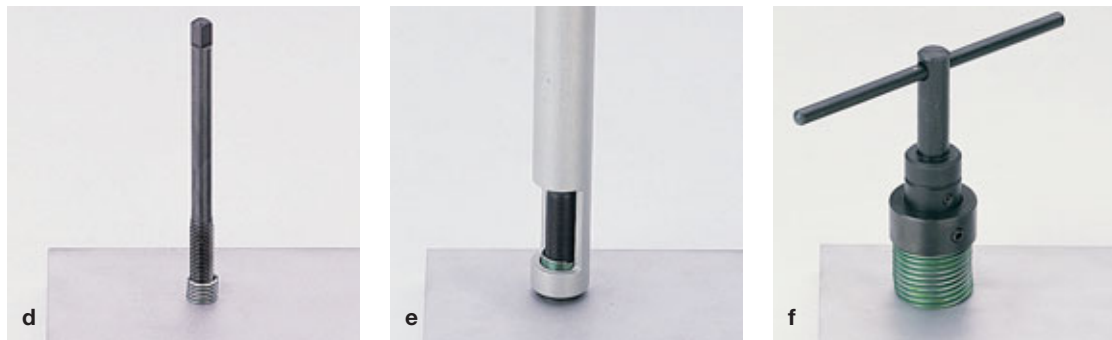

Breaking off the tang

To produce a through-hole thread, the tang is broken off at the notch. For that, a tang break-off tool is used (g and h). For threads from M 14 (fine and normal pitch), the tang can be removed with long nose pliers (i). For blind-hole threads, the tang does not have to be removed if the maximum screw-in depth t_3 of the screw is observed.

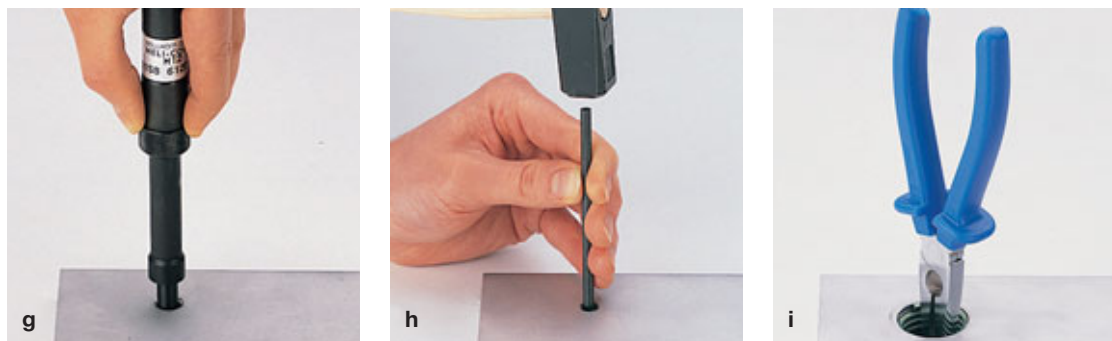

To read the table,
please open this page.

HELICOIL® Plus thread inserts

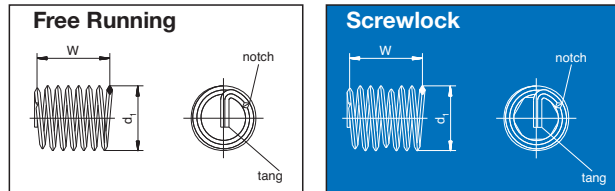

W and d₁ are the control values for thread inserts (Free Running and Screwlock) before they have been installed. The length can only be measured for installed thread inserts.

Holding thread

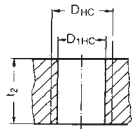

Assembly

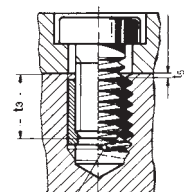
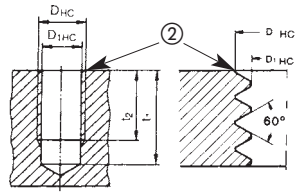
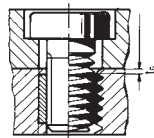

tang not broken off

- d = Nominal thread diameter
- P = Thread pitch
- d₁ = Outside diameter of thread insert prior to installation
- W = Number of threads prior to installation
- D_{HC} = Outside diameter of the parent thread
- D_{1HC} = Crest diameter
- B = Suitable twist drill diameter. Please note: D_{1HC} is critical for selecting the correct twist drill diameter.
- t₁ = Minimum depth of tapped hole according to DIN 76 – Part 1 (guide value)
- t₂ = The nominal length of the thread insert corresponds to the minimum length of the full parent thread for blind holes or the minimum plate thickness for a through hole.
- t₃ = Maximum screw-in depth when the tang is not removed
- t₅ = Distance of the thread insert from the joint face = 0.25 to 0.5 P, if t₂ corresponds to the above-mentioned minimum value

② Prior to tapping, counter-bore 90° and deburr. Outside diameter of **countersink** = **D_{HC} + 0.1 mm**.

■ When you use HELICOIL® Plus thread inserts for volume production, we recommend to add at least 1 x P to values t₁ and t₂.

① Materials and surface finishes must be indicated with the 5th digit of the item no:

Example:

- 0 = Stainless steel A 2, X 5 CrNi 18 10 4130 002 0005
 1 = Bronze, CuSn 6
 2 = Nimonic 90, NiCr 20 Co 18 Ti, silver plated*
 3 = Stainless steel A 4, X 6 CrNiMoTi 17 12 2
 4 = Inconel X 750, NiCr 15 Fe 7 TiAl, silver plated*
 5 = Inconel X 750, NiCr 15 Fe 7 TiAl, bright
 6 = Stainless steel A 2, X 5 CrNi 18 10, cadmium-plated
 7 = Stainless steel A 2, X 5 CrNi 18 10, magazined**
 8 = Bronze, CuSn 6, magazined**
 Other materials on request

* Use special tools for HELICOIL® Screwlock

**See page 24

All measures in mm. Technical changes reserved.

HELICOIL® Plus thread inserts

d	P	t ₂ min.*		W	d ₁ min. max.	D _{1HC} min. max.	B	t ₃ max.	D _{HC} min.	Free Running Item No ^①	Screwlock Item No ^①
		x d	mm								
M 2	0.40	1 d	2.0	2.9	2.60 2.80	2.09 2.18	2.10	1.8 2.8 3.8 4.8 5.8	2.52	4130 002 0002	on request
		1.5 d	3.0	4.9						4130 002 0003	
		2 d	4.0	6.9						4130 002 0004	
		2.5 d	5.0	8.9						4130 002 0005	
		3 d	6.0	10.9						4130 002 0006	
M 2.5	0.45	1 d	2.5	3.5	3.30 3.50	2.60 2.70	2.60	2.3 3.5 4.8 6.0 7.3	3.08	4130 025 0025	4132 025 0025
		1.5 d	3.75	5.9						4130 025 0375	4132 025 0375
		2 d	5.0	8.1						4130 025 0005	4132 025 0005
		2.5 d	6.25	10.5						4130 025 0625	4132 025 0625
		3 d	7.5	12.9						4130 025 0075	4132 025 0075
M 3	0.5	1 d	3.0	3.9	3.80 4.00	3.11 3.22	3.20	2.7 4.2 5.7 7.2 8.7	3.65	4130 003 0003	4132 003 0003
		1.5 d	4.5	6.3						4130 003 0045	4132 003 0045
		2 d	6.0	8.7						4130 003 0006	4132 003 0006
		2.5 d	7.5	11.1						4130 003 0075	4132 003 0075
		3 d	9.0	13.5						4130 003 0009	4132 003 0009
M 3.5	0.6	1 d	3.5	3.7	4.42 4.60	3.63 3.76	3.70	3.2 5.0 6.7 8.5 10.2	4.28	4130 035 0035	4132 035 0035
		1.5 d	5.25	6.3						4130 035 0053	4132 035 0053
		2 d	7.0	8.7						4130 035 0007	4132 035 0007
		2.5 d	8.75	11.2						4130 035 0875	4132 035 0875
		3 d	10.5	13.3						4130 035 0105	4132 035 0105
M 4	0.7	1 d	4.0	3.7	5.05 5.25	4.15 4.29	4.20	3.6 5.6 7.6 9.6 11.6	4.91	4130 004 0004	4132 004 0004
		1.5 d	6.0	6.1						4130 004 0006	4132 004 0006
		2 d	8.0	8.4						4130 004 0008	4132 004 0008
		2.5 d	10.0	10.9						4130 004 0010	4132 004 0010
		3 d	12.0	13.2						4130 004 0012	4132 004 0012
M 5	0.8	1 d	5.0	4.3	6.35 6.60	5.17 5.33	5.20	4.6 7.1 9.6 12.1 14.6	6.04	4130 005 0005	4132 005 0005
		1.5 d	7.5	6.9						4130 005 0075	4132 005 0075
		2 d	10.0	9.7						4130 005 0010	4132 005 0010
		2.5 d	12.5	12.3						4130 005 0125	4132 005 0125
		3 d	15.0	14.8						4130 005 0015	4132 005 0015
M 6	1.0	1 d	6.0	4.2	7.60 7.85	6.22 6.41	6.30	5.5 8.5 11.5 14.5 17.5	7.30	4130 006 0006	4132 006 0006
		1.5 d	9.0	6.9						4130 006 0009	4132 006 0009
		2 d	12.0	9.6						4130 006 0012	4132 006 0012
		2.5 d	15.0	12.3						4130 006 0015	4132 006 0015
		3 d	18.0	14.6						4130 006 0018	4132 006 0018
M 7	1.0	1 d	7.0	5.3	8.65 8.90	7.22 7.41	7.30	6.5 10.0 13.5 17.0 20.5	8.30	4130 007 0007	4132 007 0007
		1.5 d	10.5	8.2						4130 007 0105	4132 007 0105
		2 d	14.0	11.1						4130 007 0014	4132 007 0014
		2.5 d	17.5	14.3						4130 007 0175	4132 007 0175
		3 d	21.0	17.4						4130 007 0021	4132 007 0021
M 8	1.25	1 d	8.0	4.7	9.85 10.10	8.27 8.48	8.40	7.4 11.4 15.4 19.4 23.4	9.62	4130 008 0008	4132 008 0008
		1.5 d	12.0	7.4						4130 008 0012	4132 008 0012
		2 d	16.0	10.6						4130 008 0016	4132 008 0016
		2.5 d	20.0	13.5						4130 008 0020	4132 008 0020
		3 d	24.0	16.4						4130 008 0024	4132 008 0024
M 8 x 1	1.0	1 d	8.0	6.1	9.85 10.10	8.22 8.41	8.30	7.5 11.5 15.5 19.5 23.5	9.30	4130 008 3008	4132 008 3008
		1.5 d	12.0	9.5						4130 008 3012	4132 008 3012
		2 d	16.0	12.9						4130 008 3016	4132 008 3016
		2.5 d	20.0	16.5						4130 008 3020	4132 008 3020
		3 d	24.0	19.9						4130 008 3024	4132 008 3024

*Intermediate lengths also available.

① See flap page 17 b

Lead time of items: approx. 3 weeks (10,000 pieces max.).

We have items with blue order numbers in stock – subject to being unsold.

HELICOIL® Plus thread inserts

d	P	t ₂ min.*		W	d ₁ min. max.	D _{1HC} min. max.	B	t ₃ max.	D _{HC} min.	Free Running Item No [®]	Screwlock Item No [®]
		x d	mm								
M 9	1.25	1 d	9.0	5.3	10.85 11.10	9.27 9.48	9.40	8.4	10.62	4130 009 0009	on request
		1.5 d	13.5	8.6				12.9		4130 009 0135	
		2 d	18.0	11.9				17.4		4130 009 0018	
		2.5 d	22.5	15.3				21.9		4130 009 0225	
		3 d	27.0	18.1				26.4		4130 009 0027	
M 10	1.5	1 d	10.0	5.0	12.10 12.50	10.32 10.56	10.50	9.2	11.95	4130 010 0010	4132 010 0010
		1.5 d	15.0	8.1				14.2		4130 010 0015	4132 010 0015
		2 d	20.0	11.2				19.2		4130 010 0020	4132 010 0020
		2.5 d	25.0	14.2				24.2		4130 010 0025	4132 010 0025
		3 d	30.0	17.2				29.2		4130 010 0030	4132 010 0030
M 10 x 1	1.0	1 d	10.0	7.6	12.10 12.50	10.22 10.41	10.25	9.5	11.30	4130 010 3010	4132 010 3010
		1.5 d	15.0	12.1				14.5		4130 010 3015	4132 010 3015
		2 d	20.0	16.3				19.5		4130 010 3020	4132 010 3020
		2.5 d	25.0	20.7				24.5		4130 010 3025	4132 010 3025
		3 d	30.0	25.0				29.5		4130 010 3030	4132 010 3030
M 10 x 1.25	1.25	1 d	10.0	6.0	12.10 12.50	10.27 10.48	10.40	9.4	11.62	4130 010 9010	4132 010 9010
		1.5 d	15.0	9.7				14.4		4130 010 9015	4132 010 9015
		2 d	20.0	13.1				19.4		4130 010 9020	4132 010 9020
		2.5 d	25.0	16.9				24.4		4130 010 9025	4132 010 9025
		3 d	30.0	20.1				29.4		4130 010 9030	4132 010 9030
M 11	1.5	1 d	11.0	5.6	13.10 13.50	11.33 11.56	11.50	10.2	12.95	4130 011 0011	on request
		1.5 d	16.5	9.0				15.7		4130 011 0165	
		2 d	22.0	12.3				21.2		4130 011 0022	
		2.5 d	27.5	15.7				26.7		4130 011 0275	
		3 d	33.0	19.1				32.2		4130 011 0033	
M 12	1.75	1 d	12.0	5.2	14.40 14.80	12.38 12.64	12.50	11.1	14.27	4130 012 0012	4132 012 0012
		1.5 d	18.0	8.4				17.1		4130 012 0018	4132 012 0018
		2 d	24.0	11.7				23.1		4130 012 0024	4132 012 0024
		2.5 d	30.0	14.7				29.1		4130 012 0030	4132 012 0030
		3 d	36.0	18.0				35.1		4130 012 0036	4132 012 0036
M 12 x 1	1.0	1 d	12.0	9.3	14.40 14.80	12.22 12.41	12.25	11.5	13.30	4130 012 3012	on request
		1.5 d	18.0	14.5				17.5		4130 012 3018	
		2 d	24.0	19.5				23.5		4130 012 3024	
		2.5 d	30.0	24.8				29.5		4130 012 3030	
		3 d	36.0	30.0				35.5		4130 012 3036	
M 12 x 1.25	1.25	1 d	12.0	7.4	14.40 14.80	12.27 12.48	12.25	11.4	13.62	4130 012 9012	4132 012 9012
		1.5 d	18.0	11.6				17.4		4130 012 9018	4132 012 9018
		2 d	24.0	15.9				23.4		4130 012 9024	4132 012 9024
		2.5 d	30.0	20.0				29.4		4130 012 9030	4132 012 9030
		3 d	36.0	24.3				35.4		4130 012 9036	4132 012 9036
M 12 x 1.5	1.5	1 d	12.0	6.2	14.40 14.80	12.32 12.56	12.50	11.2	13.95	4130 012 4012	4132 012 4012
		1.5 d	18.0	9.8				17.2		4130 012 4018	4132 012 4018
		2 d	24.0	13.5				23.2		4130 012 4024	4132 012 4024
		2.5 d	30.0	17.1				29.2		4130 012 4030	4132 012 4030
		3 d	36.0	20.8				35.2		4130 012 4036	4132 012 4036

*Intermediate lengths also available.

® See flap page 17b

Lead time of items: approx. 3 weeks (10,000 pieces max.).

We have items with blue order numbers in stock – subject to being unsold.

HELICOIL® Plus thread inserts

d	P	t ₂ min.*		W	d ₁ min. max.	D _{1HC} min. max.	B	t ₃ max.	D _{HC} min.	Free Running Item No [®]	Screwlock Item No [®]
		x d	mm								
M 14	2.0	1 d	14.0	5.6	16.80 17.20	14.43 14.73	14.50	13.0	16.60	4130 014 0014	4132 014 0014
		1.5 d	21.0	8.8				20.0		4130 014 0021	4132 014 0021
		2 d	28.0	12.0				27.0		4130 014 0028	4132 014 0028
		2.5 d	35.0	15.2				34.0		4130 014 0035	4132 014 0035
M 14 x 1	1.0	1 d	14.0	11.2	16.80 17.20	14.22 14.41	14.25	13.5	15.30	4130 014 3014	on request
		1.5 d	21.0	17.2				20.5		4130 014 3021	
		2 d	28.0	23.2				27.5		4130 014 3028	
		2.5 d	35.0	29.2				34.5		4130 014 3035	
M 14 x 1.25	1.25	spark plug thread	8.4	4.6	16.80 17.20	14.27 14.48	14.25	7.8	15.62	4130 014 9084	on request
			12.4	7.4				11.8		4130 014 9124	
			14.4	9.1				13.8		4130 014 9144	
			16.4	10.2				15.8		4130 014 9164	
M 14 x 1.5	1.5	1 d	14.0	7.4	16.80 17.20	14.38 14.56	14.50	13.2	15.95	4130 014 4014	4132 014 4014
		1.5 d	21.0	11.6				20.2		4130 014 4021	4132 014 4021
		2 d	28.0	15.7				27.2		4130 014 4028	4132 014 4028
		2.5 d	35.0	19.9				34.2		4130 014 4035	4132 014 4035
M 16	2.0	1 d	16.0	6.5	19.00 19.40	16.43 16.73	16.50	15.0	18.60	4130 016 0016	4132 016 0016
		1.5 d	24.0	10.1				23.0		4130 016 0024	4132 016 0024
		2 d	32.0	13.8				31.0		4130 016 0032	4132 016 0032
		2.5 d	40.0	17.5				39.0		4130 016 0040	4132 016 0040
M 16 x 1.5	1.5	1 d	16.0	8.7	19.00 19.40	16.32 16.56	16.50	15.2	17.95	4130 016 4016	4132 016 4016
		1.5 d	24.0	13.4				23.2		4130 016 4024	4132 016 4024
		2 d	32.0	18.1				31.2		4130 016 4032	4132 016 4032
		2.5 d	40.0	22.9				39.2		4130 016 4040	4132 016 4040
M 18	2.5	0.5 d	9.0	2.3	21.50 22.00	18.54 18.90	18.75	7.7	21.25	4130 018 0009	4132 018 0009
		0.75 d	13.5	3.8				12.2		4130 018 0135	4132 018 0135
		1 d	18.0	5.6				16.7		4130 018 0018	4132 018 0018
		1.5 d	27.0	9.0				25.7		4130 018 0027	4132 018 0027
		2 d	36.0	12.3				34.7		4130 018 0036	4132 018 0036
M 18 x 1.5	1.5	0.5 d	9.0	4.2	21.50 22.00	18.32 18.56	18.50	8.2	19.95	4130 018 4009	4132 018 4009
		0.75 d	13.5	7.0				12.7		4130 018 4135	4132 018 4135
		1 d	18.0	9.5				17.2		4130 018 4018	4132 018 4018
		1.5 d	27.0	14.9				26.2		4130 018 4027	4132 018 4027
		2 d	36.0	20.2				35.2		4130 018 4036	4132 018 4036
M 18 x 2	2.0	0.5 d	9.0	3.1	21.50 22.00	18.43 18.72	18.50	8.0	20.60	4130 018 5009	4132 018 5009
		0.75 d	13.5	5.1				12.5		4130 018 5135	4132 018 5135
		1 d	18.0	7.1				17.0		4130 018 5018	4132 018 5018
		1.5 d	27.0	11.2				26.0		4130 018 5027	4132 018 5027
		2 d	36.0	15.1				35.0		4130 018 5036	4132 018 5036

*Intermediate lengths also available.

[®] See flap page 17b

Lead time of items: approx. 3 weeks (10,000 pieces max.).

We have items with blue order numbers in stock – subject to being unsold.

HELICOIL® Plus thread inserts

d	P	t ₂ min.*		W	d ₁ min. max.	D _{1HC} min. max.	B	t ₃ max.	D _{HC} min.	Free Running Item No [®]	Screwlock Item No [®]
		x d	mm								
M 20	2.5	0.5 d	10.0	2.7	23.70 24.20	20.54 20.90	20.75	8.7	23.25	4130 020 0010	4132 020 0010
		0.75 d	15.0	4.5				13.7		4130 020 0015	4132 020 0015
		1 d	20.0	6.3				18.7		4130 020 0020	4132 020 0020
		1.5 d	30.0	10.0				28.7		4130 020 0030	4132 020 0030
		2 d	40.0	13.7				38.7		4130 020 0040	4132 020 0040
M 20 x 1.5	1.5	0.5 d	10.0	4.9	23.70 24.20	20.32 20.56	20.50	9.2	21.95	4130 020 4010	4132 020 4010
		0.75 d	15.0	7.9				14.2		4130 020 4015	4132 020 4015
		1 d	20.0	10.7				19.2		4130 020 4020	4132 020 4020
		1.5 d	30.0	16.7				29.2		4130 020 4030	4132 020 4030
		2 d	40.0	22.4				39.2		4130 020 4040	4132 020 4040
M 20 x 2	2.0	0.5 d	10.0	3.5	23.70 24.20	20.43 20.73	20.50	9.0	22.60	4130 020 5010	4132 020 5010
		0.75 d	15.0	5.8				14.0		4130 020 5015	4132 020 5015
		1 d	20.0	8.0				19.0		4130 020 5020	4132 020 5020
		1.5 d	30.0	12.5				29.0		4130 020 5030	4132 020 5030
		2 d	40.0	16.8				39.0		4130 020 5040	4132 020 5040
M 22	2.5	0.5 d	11.0	3.0	26.30 26.80	22.54 22.90	22.75	9.7	25.25	4130 022 0011	4132 022 0011
		0.75 d	16.5	5.0				15.2		4130 022 0165	4132 022 0165
		1 d	22.0	6.9				20.7		4130 022 0022	4132 022 0022
		1.5 d	33.0	10.9				31.7		4130 022 0033	4132 022 0033
		2 d	44.0	15.0				42.7		4130 022 0044	4132 022 0044
M 22 x 1.5	1.5	0.5 d	11.0	5.5	26.30 26.80	22.32 22.56	22.50	10.2	23.95	4130 022 4011	on request
		0.75 d	16.5	8.6				15.7		4130 022 4165	
		1 d	22.0	11.7				21.2		4130 022 4022	
		1.5 d	33.0	18.1				32.2		4130 022 4033	
		2 d	44.0	24.5				43.2		4130 022 4044	
M 22 x 2	2.0	0.5 d	11.0	3.9	26.30 26.80	22.43 22.73	22.50	10.0	24.60	4130 022 5011	4132 022 5011
		0.75 d	16.5	6.4				15.5		4130 022 5165	4132 022 5165
		1 d	22.0	8.7				21.0		4130 022 5022	4132 022 5022
		1.5 d	33.0	13.6				32.0		4130 022 5033	4132 022 5033
		2 d	44.0	18.4				43.0		4130 022 5044	4132 022 5044
M 24	3.0	0.5 d	12.0	2.6	28.60 29.10	24.65 25.05	24.75	10.5	27.90	4130 024 0012	4132 024 0012
		0.75 d	18.0	4.5				16.5		4130 024 0018	4132 024 0018
		1 d	24.0	6.2				22.5		4130 024 0024	4132 024 0024
		1.5 d	36.0	10.0				34.5		4130 024 0036	4132 024 0036
		2 d	48.0	14.0				46.5		4130 024 0048	on request
M 24 x 1.5	1.5	0.5 d	12.0	6.0	28.60 29.10	24.33 24.56	24.50	11.2	25.95	4130 024 4012	on request
		0.75 d	18.0	9.5				17.2		4130 024 4018	
		1 d	24.0	12.9				23.2		4130 024 4024	
		1.5 d	36.0	19.8				35.2		4130 024 4036	
		2 d	48.0	26.7				47.2		4130 024 4048	
M 24 x 2	2.0	0.5 d	12.0	4.3	28.60 29.10	24.43 24.73	24.50	11.0	26.60	4130 024 5012	4132 024 5012
		0.75 d	18.0	7.0				17.0		4130 024 5018	4132 024 5018
		1 d	24.0	9.6				23.0		4130 024 5024	4132 024 5024
		1.5 d	36.0	15.0				35.0		4130 024 5036	4132 024 5036
		2 d	48.0	20.2				47.0		4130 024 5048	4132 024 5048

*Intermediate lengths also available.

[®] See flap page 17b

Lead time of items: approx. 3 weeks (10,000 pieces max.).

We have items with blue order numbers in stock – subject to being unsold.

HELICOIL® Plus thread inserts

d	P	t ₂ min.*		W	d ₁ min. max.	D _{1HC} min. max.	B	t ₃ max.	D _{HC} min.	Free Running Item No [®]	Screwlock Item No [®]
		x d	mm								
M 26 x 1.5	1.5	0.5 d	13.0	6.5	31.00 31.50	26.33 26.56	26.50	12.2	27.95	4130 026 4013	on request
		0.75 d	19.5	10.3				18.7		4130 026 4195	
		1 d	26.0	14.0				25.2		4130 026 4026	
		1.5 d	39.0	21.6				38.2		4130 026 4039	
		2 d	52.0	29.1				51.2		4130 026 4052	
M 27	3.0	0.5 d	13.5	3.2	32.20 32.70	27.65 28.05	27.75	12.0	30.90	4130 027 0135	4132 027 0135
		0.75 d	20.3	5.0				18.8		4130 027 0203	4132 027 0203
		1 d	27.0	7.1				25.5		4130 027 0027	4132 027 0027
		1.5 d	40.5	11.4				39.0		4130 027 0405	4132 027 0405
		2 d	54.0	15.4				52.5		4130 027 0054	4132 027 0054
M 27 x 1.5	1.5	0.5 d	13.5	6.7	32.20 32.70	27.33 27.56	27.50	12.7	28.95	4130 027 4135	on request
		0.75 d	20.3	10.7				19.5		4130 027 4203	
		1 d	27.0	14.6				26.2		4130 027 4027	
		1.5 d	40.5	22.6				39.7		4130 027 4405	
		2 d	54.0	30.0				53.2		4130 027 4054	
M 27 x 2	2.0	0.5 d	13.5	5.1	32.20 32.70	27.43 27.73	27.50	12.5	29.60	4130 027 5135	on request
		0.75 d	20.3	7.9				19.3		4130 027 5203	
		1 d	27.0	10.8				26.0		4130 027 5027	
		1.5 d	40.5	16.8				39.5		4130 027 5405	
		2 d	54.0	22.6				53.0		4130 027 5054	
M 28 x 1.5	1.5	0.5 d	14.0	7.1	33.10 33.60	28.33 28.56	28.50	13.2	29.95	4130 028 4014	on request
		0.75 d	21.0	11.1				20.2		4130 028 4021	
		1 d	28.0	15.2				27.2		4130 028 4028	
		1.5 d	42.0	23.3				41.2		4130 028 4042	
		2 d	56.0	31.4				55.2		4130 028 4056	
M 30	3.5	0.5 d	15.0	3.0	35.20 35.70	30.76 31.21	31.00	13.2	34.55	4130 030 0015	4132 030 0015
		0.75 d	22.5	4.9				20.7		4130 030 0225	4132 030 0225
		1 d	30.0	7.0				28.2		4130 030 0030	4132 030 0030
		1.5 d	45.0	11.0				43.2		4130 030 0045	4132 030 0045
		2 d	60.0	14.9				58.2		4130 030 0060	4132 030 0060
M 30 x 1.5	1.5	0.5 d	15.0	7.8	35.20 35.70	30.33 30.56	30.50	14.2	31.95	4130 030 4015	on request
		0.75 d	22.5	12.2				21.7		4130 030 4225	
		1 d	30.0	16.5				29.2		4130 030 4030	
		1.5 d	45.0	25.3				44.2		4130 030 4045	
		2 d	60.0	34.0				59.2		4130 030 4060	
M 30 x 2	2.0	0.5 d	15.0	5.7	35.20 35.70	30.43 30.73	30.50	14.0	32.60	4130 030 5015	on request
		0.75 d	22.5	9.0				21.5		4130 030 5225	
		1 d	30.0	12.3				29.0		4130 030 5030	
		1.5 d	45.0	19.0				44.0		4130 030 5045	
		2 d	60.0	25.5				59.0		4130 030 5060	
M 33	3.5	0.5 d	16.5	3.4	38.30 38.80	33.76 34.21	34.00	14.7	37.55	4130 033 0165	on request
		0.75 d	24.8	5.6				23.0		4130 033 0248	on request
		1 d	33.0	7.8				31.2		4130 033 0033	4132 033 0033
		1.5 d	49.5	12.2				47.7		4130 033 0495	4132 033 0495
		2 d	66.0	16.5				64.2		4130 033 0066	4132 033 0066

*Intermediate lengths also available.

[®] See flap page 17b

Lead time of items: approx. 3 weeks (10,000 pieces max.).

We have items with blue order numbers in stock – subject to being unsold.

HELICOIL® Plus thread inserts

d	P	t ₂ min.*		W	d ₁ min. max.	D _{1HC} min. max.	B	t ₃ max.	D _{HC} min.	Free Running Item No [®]	Screwlock Item No [®]
		x d	mm								
M 33 x 2	2.0	0.5 d	16.5	6.4	38.30 38.80	33.43 33.73	33.50	15.5	35.60	4130 033 5165	on request
		0.75 d	24.8	10.1				23.8		4130 033 5248	
		1 d	33.0	13.7				32.0		4130 033 5033	
		1.5 d	49.5	21.2				48.5		4130 033 5495	
		2 d	66.0	28.4				65.0		4130 033 5066	
M 36	4.0	0.5 d	18.0	3.2	42.10 42.60	36.87 37.34	37.00	16.0	41.20	4130 036 0018	on request
		0.75 d	27.0	5.0				25.0		4130 036 0027	on request
		1 d	36.0	7.0				34.0		4130 036 0036	4132 036 0036
		1.5 d	54.0	11.1				52.0		4130 036 0054	4132 036 0054
		2 d	72.0	15.2				70.0		4130 036 0072	4132 036 0072
M 36 x 1.5	1.5	0.5 d	18.0	9.5	42.10 42.60	36.33 36.56	36.50	17.2	37.95	4130 036 4018	on request
		0.75 d	27.0	14.7				26.2		4130 036 4027	
		1 d	36.0	19.9				35.2		4130 036 4036	
		1.5 d	54.0	30.5				53.2		4130 036 4054	
		2 d	72.0	41.0				71.2		4130 036 4072	
M 36 x 2	2.0	0.5 d	18.0	6.8	42.10 42.60	36.43 36.73	36.50	17.0	38.60	4130 036 5018	on request
		0.75 d	27.0	10.3				26.0		4130 036 5027	
		1 d	36.0	14.1				35.0		4130 036 5036	
		1.5 d	54.0	21.9				53.0		4130 036 5054	
		2 d	72.0	31.1				71.0		4130 036 5072	
M 36 x 3**	3.0	0.5 d	18.0	4.4	42.10 42.60	36.65 37.05	37.00	16.5	39.90	4130 036 6018	4132 036 6018
		0.75 d	27.0	7.2				25.5		4130 036 6027	4132 036 6027
		1 d	36.0	9.9				34.5		4130 036 6036	4132 036 6036
		1.5 d	54.0	15.3				52.5		4130 036 6054	4132 036 6054
		2 d	72.0	20.5				70.5		4130 036 6072	4132 036 6072
M 39	4.0	0.75 d	29.3	5.5	45.10 45.60	39.87 40.34	40.00	23.4	44.20	4130 039 0293	4132 039 0293
		1 d	39.0	7.7				33.1		4130 039 0039	4132 039 0039
		1.25 d	48.8	9.9				42.9		4130 039 0488	4132 039 0488
		1.5 d	58.5	12.3				52.6		4130 039 0585	4132 039 0585
		2 d	78.0	16.6				72.1		4130 039 0078	4132 039 0078
M 39 x 2	2.0	0.5 d	19.5	7.5	45.10 45.60	39.43 39.73	39.50	16.6	41.60	4130 039 5195	4132 039 5195
		0.75 d	29.3	11.9				26.3		4130 039 5293	4132 039 5293
		1 d	39.0	16.3				36.1		4130 039 5039	4132 039 5039
		1.25 d	48.8	20.6				45.8		4130 039 5488	4132 039 5488
		1.5 d	58.5	25.0				55.6		4130 039 5585	4132 039 5585
M 39 x 3	3.0	0.5 d	19.5	4.9	45.10 45.60	39.65 40.05	40.00	15.1	42.90	4130 039 6195	4132 039 6195
		0.75 d	29.3	7.8				24.8		4130 039 6293	4132 039 6293
		1 d	39.0	10.8				34.6		4130 039 6039	4132 039 6039
		1.25 d	48.8	13.7				44.3		4130 039 6488	4132 039 6488
		1.5 d	58.5	16.8				54.1		4130 039 6585	4132 039 6585
M 42	4.5	0.5 d	21.0	3.3	48.50 49.00	42.98 43.05	43.00	18.7	47.85	4130 042 0021	on request
		0.75 d	35.0	6.2				32.7		4130 042 0035	
		1 d	42.0	7.3				39.7		4130 042 0042	
		1.25 d	52.5	9.5				50.2		4130 042 0525	
		1.5 d	63.0	11.6				60.7		4130 042 0063	
		2 d	84.0	15.6				81.7		4130 042 0084	

*Intermediate lengths also available. HELICOIL® Plus > M 42 on request.

** Further nominal thread diameters available. See "Thread types" table on page 12.

© See flap page 17b

Lead time of items: approx. 3 weeks (10,000 pieces max.).

We have items with blue order numbers in stock – subject to being unsold.



Magazined HELICOIL® Plus thread inserts are particularly suitable for processing smaller thread inserts. Manual taps as well as stationary installation devices are also available.

Advantages for processing in small and large scale production:

- High process reliability
- Improved working conditions for series installation
- Improved performance due to safe feeding
- Cost reduction

Imperial dimensions: See separate catalogue No 0101.

Thread nominal Ø	Nominal length	Magazined with roller diameter = 320 mm			Magazined with roller diameter = 220 mm		
		Number of inserts	HELICOIL® Plus Free Running Item No	HELICOIL® Plus Screwlock Item No	Number of inserts	HELICOIL® Plus Free Running Item No	HELICOIL® Plus Screwlock Item No
M 2	1.5 x d	–	–	–	–	–	–
	2 x d	4500*	4130 702 0008*	4132 702 0008*	1000*	4130 702 0028*	4132 702 0028*
	3 x d	3000*	4130 702 0012*	4132 702 0012*	–	–	–
M 2.5	1 x d	5000	4130 725 0004	4132 725 0004	1000	4130 725 0024	4132 725 0024
	1.5 x d	4000	4130 725 0006	4132 725 0006	1000	4130 725 0026	4132 725 0026
	2 x d	3000	4130 725 0008	4132 725 0008	1000	4130 725 0028	4132 725 0028
M 3	1 x d	4000	4130 703 0004	4132 703 0004	1000	4130 703 0024	4132 703 0024
	1.5 x d	2800	4130 703 0006	4132 703 0006	1000	4130 703 0026	4132 703 0026
	2 x d	2000	4130 703 0008	4132 703 0008	1000	4130 703 0028	4132 703 0028
M 3.5	1 x d	5000*	4130 735 0004*	4132 735 0004*	1000*	4130 735 0024*	4132 735 0024*
	1.5 x d	5000*	4130 735 0006*	4132 735 0006*	1000*	4130 735 0026*	4132 735 0026*
	2 x d	5000*	4130 735 0008*	4132 735 0008*	1000*	4130 735 0028*	4132 735 0028*
M 4	1 x d	2200	4130 704 0004	4132 704 0004	1000	4130 704 0024	4132 704 0024
	1.5 x d	1500	4130 704 0006	4132 704 0006	1000	4130 704 0026	4132 704 0026
	2 x d	1300	4130 704 0008	4132 704 0008	–	–	–
M 5	1 x d	1500	4130 705 0004	4132 705 0004	1000	4130 705 0024	4132 705 0024
	1.5 x d	1000	4130 705 0006	4132 705 0006	–	–	–
	2 x d	800	4130 705 0008	4132 705 0008	–	–	–
M 6	1 x d	1100	4130 706 0004	4132 706 0004	*	*	*
	1.5 x d	750	4130 706 0006	4132 706 0006	–	–	–
	2 x d	550	4130 706 0008	4132 706 0008	–	–	–
M 8	1 x d	650	4130 708 0004	4132 708 0004	–	–	–
	1.5 x d	400	4130 708 0006	4132 708 0006	–	–	–
	2 x d	300	4130 708 0008	4132 708 0008	–	–	–
M 10	1 x d	400	4130 710 0004	4132 710 0004	–	–	–
	1.5 x d	270	4130 710 0006	4132 710 0006	–	–	–
	2 x d	200	4130 710 0008	4132 710 0008	–	–	–

HELICOIL® Plus “pick-and-place” equipment



Installation of HELICOIL® Plus

Thread nominal Ø	Item No
M 2	4148 002 0000
M 2.5	4148 002 0000
M 3	4148 002 0000
M 3.5	4148 002 0000
M 4	4148 004 0000
M 5	4148 004 0000
M 6	4148 006 0000
M 8	4148 008 0000



“Pick-and-place” equipment

Number of inserts	Strips for “pick-and-place”		Thread nominal Ø
	HELICOIL® Plus Free Running Item No	HELICOIL® Plus Screwlock Item No	
150	4130 702 0016	4132 702 0016	M 2
150	4130 702 0018	4132 702 0018	
–	–	–	
150	4130 725 0014	4132 725 0014	M 2.5
150	4130 725 0016	4132 725 0016	
150	4130 725 0018	4132 725 0018	
100	4130 703 0014	4132 703 0014	M 3
100	4130 703 0016	4132 703 0016	
100	4130 703 0018	4132 703 0018	
100	4130 735 0014	4132 735 0014	M 3.5
100	4130 735 0016	4132 735 0016	
100	4130 735 0018	4132 735 0018	
100	4130 704 0014	4132 704 0014	M 4
100	4130 704 0016	4132 704 0016	
100	4130 704 0018	4132 704 0018	
100	4130 705 0014	4132 705 0014	M 5
100	4130 705 0016	4132 705 0016	
100	4130 705 0018	4132 705 0018	
100	4130 706 0014	4132 706 0014	M 6
100	4130 706 0016	4132 706 0016	
100	4130 706 0018	4132 706 0018	
100	4130 708 0014	4132 708 0014	M 8
100	4130 708 0016	4132 708 0016	
100	4130 708 0018	4132 708 0018	
*	*	*	M 10
*	*	*	
*	*	*	

* on request



The **HELICOIL®** system

System modules – the fastener	Page
Technology	05
Designs	06
A close look at the advantages	08
Modular system	10
Materials	12
Design guidelines	13
Fields of application	14
Installation	16
Technical data and item numbers	18
System modules – the tool	
The thread	28
Thread tolerances and tapped hole	29
All taps at a glance	30
Manual taps	32
Machine taps	34
Combined drilling and tapping tools	36
Machine forming taps	36
Threaded plug gauges	38
Repair kits and repair range kits	39
Installation	
Installation mandrels	42
Installation tools	
Battery installation tools	44
Electrical installation tools	45
Pneumatic installation tools	46
Accessories	52
Automatic installation	53
Manual installation tools	54
Tang break-off and extraction tools	55



The thread

Even if the screw thread has the maximum size and the nut thread has the minimum size, they must still fit. That means, no dimension may exceed zero line or nominal dimension.

The **tolerance** position at the zero line is indicated by means of a capital H for internal threads and small h for external threads. The letters preceding h (g to a) mean a larger deviation for external threads. At tolerance position e, the bolt diameter is therefore smaller than at g.

The number preceding the letter is the **tolerance grade**, e.g. 6g. The higher the number, the larger the tolerance zone. The dimensions of the tolerance zones depend on the nominal size. So, the bigger the nominal size, the bigger the tolerance zone.

If no specific tolerance zone has been specified for a screw, it was produced according to tolerance zone 6g. All common screws are thus undersize.

This minus tolerance allows subsequent thin galvanic surface coating without exceeding the zero line of the finished thread.

If the protective layer shall be thicker, a tolerance position with a smaller thread diameter is required, e.g. 6e for stronger galvanic layers.

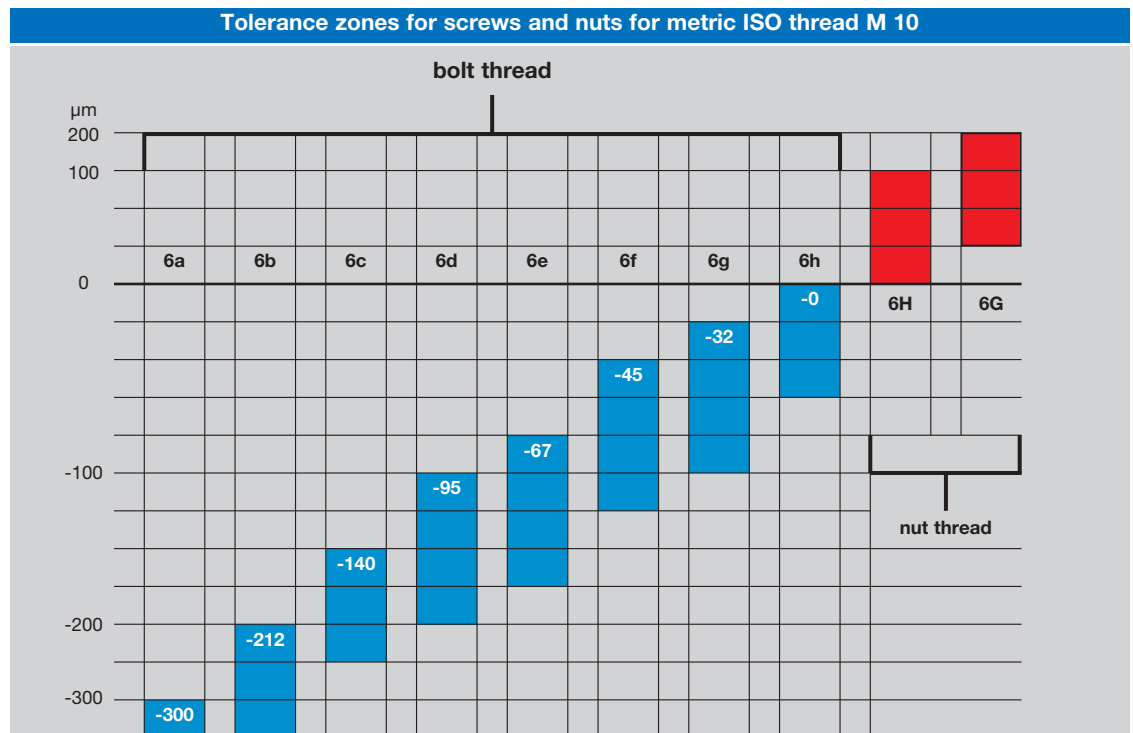

Thread tolerances of metric tapped holes

Standard tolerance

According to DIN 8140 Part 2, HELICOIL® holding threads comply with tolerance **6H mod**.
 6H mod corresponds to accuracy of tolerance **5H** (also see imprint on threaded plug gauge for HELICOIL® tapped hole).
 After the HELICOIL® Plus thread insert has been installed, the resulting ISO thread complies with tolerance **6H**.

HELICOIL®	Item code – example
Tap	For tolerance classes 6H mod and 5H , the ninth digit of the item code is 1 Example: M 10 0141 410 0 1 52
Forming tap	For tolerance classes 6H mod and 5H , the ninth digit of the item code is 0 Example: M 10 0144 110 0 0 04
Threaded plug gauges	For tolerance classes 6H mod and 5H , the ninth digit of the item code is 5 Example: M 10 0147 310 0 5 00

Industry-specific tolerance

Maximum operational reliability and economic efficiency are most important for the development in the aerospace industry. That is why the respective standards demand ISO thread tolerance **5H**. Consequently, HELICOIL® tapped hole must comply with tolerance **5H mod** corresponding to accuracy of tolerance **4H**.

After the HELICOIL® Plus thread insert has been installed, the resulting ISO thread complies with tolerance **5H**.



Order “The Blue Book”, our catalogue No 0130 for the aerospace industry or download at www.boellhoff.de/the-blue-book.

HELICOIL®	Item code – example
Tap	For tolerance classes 5H mod and 4H , the ninth digit of the item code is 2 Example: M 10 0141 410 0 2 52
Forming tap	For tolerance classes 5H mod and 4H , the ninth digit of the item code is 2 Example: M 10 0144 110 0 2 04
Threaded plug gauges	For tolerance classes 5H mod and 4H , the ninth digit of the item code is 4 Example: M 10 0147 310 0 4 00

MJ thread (ISO 5855)

No special HELICOIL® tapped hole is required for the use of threaded bolts with this thread profile.

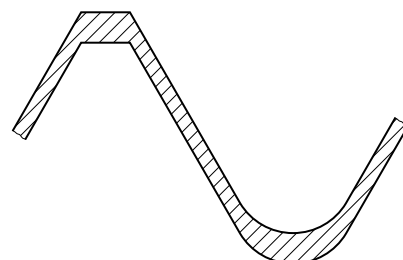

External MJ thread

HELICOIL® Plus manual and machine taps

To tap the HELICOIL® Plus tapped hole, system dependent original HELICOIL® taps must be used. We have suitable manual and machine taps on offer. The overview provides all necessary information.

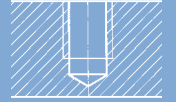
Arrangement	Manual tap Through hole and blind hole	Machine tap		Recommended guide values ^① cutting speed [m/min]*	Cooling/ lubrication
		Through hole 	Blind hole 		
Aluminium and aluminium cast alloys (short-chip)	0140.0 0140.1-2 ^② 0140.3-5 ^③	0141 1XXX XXX	0141 5XXX XXX	10/20	emulsion
Aluminium and aluminium alloys (long-chip)	0140.0 0140.1-2 ^② 0140.3-5 ^③	0141 1XXX XXX	0141 4XXX XXX	15/20	emulsion
Magnesium alloys	0140.0 0140.1-2 ^② 0140.3-5 ^③	0141 1XXX XXX	0141 4XXX XXX	10/20	dry
Steel up to 700 N/mm ² Cast iron soft $R_m \leq 250 \text{ N/mm}^2$ ** Cast iron hard $R_m > 250 \text{ N/mm}^2$ ** Malleable cast iron	0140.0 0140.1-2 ^② 0140.3-5 ^③	0141 1XXX XXX	0141 5XXX XXX	6/15 8/15 6/12 8/12	oil, emulsion petroleum/emulsion emulsion oil, emulsion
Copper Bronze/red brass Brass, tough Zinc alloy	0140.0 0140.1-2 ^② 0140.3-5 ^③	0141 1XXX XXX	0141 5XXX XXX	10/15 5/12 8/16 8/15	oil, emulsion oil, emulsion oil, emulsion oil, emulsion
Brass, brittle	0140.0 0140.1-2 ^② 0140.3-5 ^③	0141 1XXX XXX	0141 5XXX XXX	10/20	oil dry

① In individual cases, preliminary tapping tests are required for other materials.

② Set of taps (two-piece).

③ Set of taps (three-piece).

We also supply TiN-coated taps.

* Smaller value for blind holes, higher value for through holes.

** 1 N/mm² equals 1 MPa

HELICOIL® special machine taps

The standard taps from the HELICOIL® system comply with almost all practical requirements. For critical chip removal requirements, such as materials difficult to machine (stainless and heat-resisting steels, different steel and titanium alloys), we offer special machine taps. The overview provides the machine taps for the respective materials including recommended guide values for cutting speed.

Arrangement	Machine tap		Recommended guide values cutting speed [m/min]*	Cooling/lubrication
	Through hole	Blind hole		
Aluminium alloys with a high silicon content Si > 10 %	0141 9XXX 444	0141 9XXX 451	10/20	oil/emulsion
Materials difficult to machine: – Stainless steel – Ferritic/martensitic – Austenitic – Heat-resisting steel	0141 9XXX 444	0141 9XXX 451	3/8 1/4 1/4	oil/emulsion
Hard materials: – Grey cast iron – Spheroidal graphite cast iron	0141 9XXX 418	0141 9XXX 418	8/16 6/12	petroleum/emulsion
Tough, seizing materials: Electrolytic copper Bronze, hard	0141 9XXX 445	0141 9XXX 451	8/12 1/5	oil
Brass, brittle	0141 9XXX 424	0141 9XXX 424	15/25	oil
Titanium alloys: ≤ 700 N/mm ² ** > 700 N/mm ² **	0141 9XXX 444 0141 9XXX 447	0141 9XXX 451 0141 9XXX 432	2/8 1/4	oil
Plastic, soft Thermoplastic	0141 9XXX 445	0141 9XXX 451		compressed air/emulsion
Plastic, brittle Thermoset	0141 9XXX 446	0141 9XXX 446		compressed air

Example of a designation: size M 4: 0141 **9040** 451

Further taps as special versions, such as TiN-coated taps or oversize taps, on request.

* Smaller value for blind holes, higher value for through holes.

** 1 N/mm² equals 1 MPa

Manual taps for **HELICOIL® Plus**



Typ 0140.0

HELICOIL® manual tap, cutting

For cutting materials with a strength up to 700 N/mm^{2***}

For through holes

For blind holes only if sufficient chip space is provided. Minimum requirement 1 d deeper than the full thread length.



Typ 0140.1, 0140.2

HELICOIL® manual tap, two-piece set with tapered lead threads:

Pre-tap 4-lead chamfer 0140.1...

Finishing tap 2-lead chamfer 0140.2...

For cutting materials with a strength up to 700 N/mm^{2***}

For through holes and blind holes.



Typ 0140.3, 0140.4, 0140.5

HELICOIL® manual tap, three-piece set from M 36 with constant pitch

Pre-tap 4-lead chamfer 0140.3...

Intermediate tap 4-lead chamfer 0140.4...

Finishing tap 2-lead chamfer 0140.5...

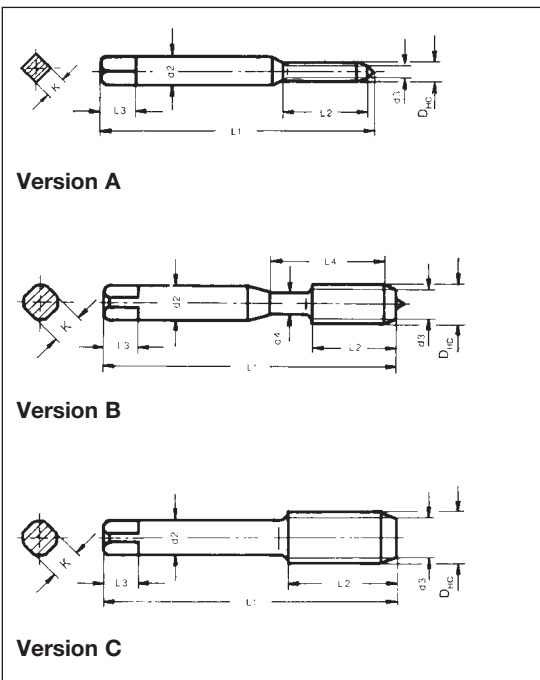

Version A

Version B

Version C

Nominal thread Ø	Cutting taps for tolerance class 5H (6H mod.)*	Taps for tolerance class 5H (6H mod.)* (1 set)	
		Pre-taps Typ 0140.1 Item No	Finishing taps Typ 0140.2 Item No
d	Typ 0140.0 Item No		
M 2	0140 002 0104	0140 102 0104	0140 202 0102
M 2.5	0140 025 0104	0140 125 0104	0140 225 0102
M 3	0140 003 0104	0140 103 0104	0140 203 0102
M 3.5	0140 035 0104	0140 135 0104	0140 235 0102
M 4	0140 004 0104	0140 104 0104	0140 204 0102
M 5	0140 005 0104	0140 105 0104	0140 205 0102
M 6	0140 006 0104	0140 106 0104	0140 206 0102
M 7	0140 007 0104	0140 107 0104	0140 207 0102
M 8	0140 008 0104	0140 108 0104	0140 208 0102
M 8 x 1	0140 008 3104	0140 108 3104	0140 208 3102
M 9	0140 009 0104	0140 109 0104	0140 209 0102
M 10	0140 010 0104	0140 110 0104	0140 210 0102
M 10 x 1	0140 010 3104	0140 110 3104	0140 210 3102
M 10 x 1.25	0140 010 9104	0140 110 9104	0140 210 9102
M 11	0140 011 0104	0140 111 0104	0140 211 0102
M 12	0140 012 0104	0140 112 0104	0140 212 0102
M 12 x 1	0140 012 3104	0140 112 3104	0140 212 3102
M 12 x 1.25	0140 012 9104	0140 112 9104	0140 212 9102
M 12 x 1.5	0140 012 4104	0140 112 4104	0140 212 4102
M 14	0140 014 0104	0140 114 0104	0140 214 0102
M 14 x 1	0140 014 3104	0140 114 3104	0140 214 3102
M 14 x 1.25	0140 014 9104	0140 114 9104	0140 214 9102
M 14 x 1.5	0140 014 4104	0140 114 4104	0140 214 4102
M 16	0140 016 0104	0140 116 0104	0140 216 0102
M 16 x 1.5	0140 016 4104	0140 116 4104	0140 216 4102
M 18	–	0140 118 0104	0140 218 0102
M 18 x 1.5	0140 018 4104	0140 118 4104	0140 218 4102
M 18 x 2	0140 018 5104	0140 118 5104	0140 218 5102
M 20	–	0140 120 0104	0140 220 0102
M 20 x 1.5	0140 020 4104	0140 120 4104	0140 220 4102
M 20 x 2	0140 020 5104	0140 120 5104	0140 220 5102
M 22	–	0140 122 0104	0140 222 0102
M 22 x 1.5	0140 022 4104	0140 122 4104	0140 222 4102
M 22 x 2	0140 022 5104	0140 122 5104	0140 222 5102
M 24	–	0140 124 0104	0140 224 0102
M 24 x 1.5	0140 024 4104	0140 124 4104	0140 224 4102
M 24 x 2	0140 024 5104	0140 124 5104	0140 224 5102
M 26 x 1.5	0140 026 4104	0140 126 4104	0140 226 4102
M 27	–	0140 127 0104	0140 227 0102
M 27 x 1.5	0140 027 4104	0140 127 4104	0140 227 4102
M 27 x 2	0140 027 5104	0140 127 5104	0140 227 5102
M 28 x 1.5	0140 028 4104	0140 128 4104	0140 228 4102
M 30	–	0140 130 0104	0140 230 0102
M 30 x 1.5	0140 030 4104	0140 130 4104	0140 230 4102
M 30 x 2	0140 030 5104	0140 130 5104	0140 230 5102
M 33	–	0140 133 0104	0140 233 0102
M 33 x 2	0140 033 5104	0140 133 5104	0140 233 5102
M 36**	–	–	–
M 36 x 1.5	0140 036 4104	0140 136 4104	0140 236 4102
M 36 x 2	0140 036 5104	0140 136 5104	0140 236 5102
M 36 x 3	0140 036 6104	0140 136 6104	0140 236 6102

For combined drilling and tapping tools, see page 36/37.

*** 1 N/mm² equals 1 MPa

Version	Min. outside Ø D _{HC}	Shank Ø h 9 d 2	Chamfer Ø d 3	Total length L 1	Max. thread length L 2	Square length L 3	Square H 12 K	L 4	d 4	Nominal thread Ø d
A	2.5	2.8	2	40	9	5	2.1	–	–	M 2
B	3.1	3.5	2.5	40	10	6	2.7	13.5	2.6	M 2.5
B	3.6	4	3	45	10	6	3	13.5	3.1	M 3
B	4.3	4.5	3.5	45	12	6	3.4	15.5	3.6	M 3.5
B	4.9	6	4	50	14	8	4.9	17.5	4.2	M 4
B	6.0	6	5	50	16	8	4.9	19.5	5.2	M 5
C	7.3	6	6	56	19	8	4.9	–	–	M 6
C	8.3	7	7	63	19	8	5.5	–	–	M 7
C	9.6	7	8	70	22	8	5.5	–	–	M 8
C	9.3	7	8	63	19	8	5.5	–	–	M 8 x 1
C	10.6	8	9	70	24	9	6.2	–	–	M 9
C	11.9	9	10	75	27	10	7	–	–	M 10
C	11.3	9	10	70	22	10	7	–	–	M 10 x 1
C	11.6	10	9	70	22	10	7	–	–	M 10 x 1.25
C	12.9	11	11	70	22	12	9	–	–	M 11
C	14.3	11	12	80	30	12	9	–	–	M 12
C	13.3	11	12	70	22	12	9	–	–	M 12 x 1
C	13.6	11	12	70	22	12	9	–	–	M 12 x 1.25
C	14.0	11	12	70	22	12	9	–	–	M 12 x 1.5
C	16.6	12	14	80	32	12	9	–	–	M 14
C	15.3	12	14	70	22	12	9	–	–	M 14 x 1
C	15.6	12	14	70	22	12	9	–	–	M 14 x 1.25
C	16.0	12	14	70	22	12	9	–	–	M 14 x 1.5
C	18.6	14	16	80	22	14	11	–	–	M 16
C	18.0	14	16	80	22	14	11	–	–	M 16 x 1.5
C	21.3	16	18	95	40	15	12	–	–	M 18
C	20.0	16	18	80	22	15	12	–	–	M 18 x 1.5
C	20.6	16	18	80	22	15	12	–	–	M 18 x 2
C	23.3	18	20	100	40	17	14.5	–	–	M 20
C	22.0	18	20	80	22	17	14.5	–	–	M 20 x 1.5
C	22.6	18	20	80	22	17	14.5	–	–	M 20 x 2
C	25.3	18	22	110	50	17	14.5	–	–	M 22
C	24.0	18	22	90	22	17	14.5	–	–	M 22 x 1.5
C	24.6	18	22	90	22	17	14.5	–	–	M 22 x 2
C	27.9	20	24	110	50	19	16	–	–	M 24
C	26.0	18	24	90	22	17	14.5	–	–	M 24 x 1.5
C	26.6	20	24	90	22	19	16	–	–	M 24 x 2
C	28.0	20	26	90	22	19	16	–	–	M 26 x 1.5
C	30.9	22	27	125	56	21	18	–	–	M 27
C	29.0	22	27	90	22	21	18	–	–	M 27 x 1.5
C	29.6	22	27	90	22	21	18	–	–	M 27 x 2
C	30.0	22	28	90	22	21	18	–	–	M 28 x 1.5
C	34.6	28	30	125	40	25	22	–	–	M 30
C	32.0	22	30	90	22	21	18	–	–	M 30 x 1.5
C	32.6	25	30	100	22	23	20	–	–	M 30 x 2
C	37.6	28	33	125	40	25	22	–	–	M 33
C	35.6	28	33	125	40	25	22	–	–	M 33 x 2
C	41.2	32	36	150	63	27	24	–	–	M 36
C	38.0	28	36	100	25	25	22	–	–	M 36 x 1.5
C	38.6	32	36	125	40	27	24	–	–	M 36 x 2
C	39.9	32	36	125	40	27	24	–	–	M 36 x 3

Further sizes on request.

* For tolerance class 4H, the ninth digit of the finishing tap item no changes from 1 to 2. The pre-tap does not change. For details see page 29.

** Set of taps (three-flute), Plus intermediate tap 0140 436 0104.

Types 0140.0 and 0140.2 can, to a limited degree, also be used as machine taps.

Shank Ø tolerance h9. They are particularly suitable for short-chip materials such as grey cast iron, brass or magnesium.

Machine taps for **HELICOIL® Plus**



Type 0141.1

HELICOIL® machine tap, straight-fluted, rake angle 10°, with spiral point 4-lead chamfer for through holes, for blind holes with deeper drilled tap hole. For materials with a strength of max. 850 N/mm^{2**}



Type 0141.4

HELICOIL® machine tap, spiral flutes 45° right-hand spiral, rake angle 15°, 2-lead chamfer for blind holes. Also suitable for aluminium casting alloys with a very low content of Si ($\leq 2\%$). For aluminium wrought alloys with a strength of up to 500 N/mm^{2**}. Up to M 8 2-flute. From M 9 3-flute and additionally also for soft steels with a strength of up to 450 N/mm^{2**}.



Type 0141.5

HELICOIL® machine tap, spiral flutes 40° right-hand spiral, rake angle 10°, 2–3-lead chamfer for blind holes, for blind holes with deeper drilled tap hole. For steels with a strength from 500 N/mm^{2**} to 850 N/mm^{2**} maximum. Also suitable for aluminium alloys with an Si content of up to approximately 10%. For Si-content > 10% see page 30.

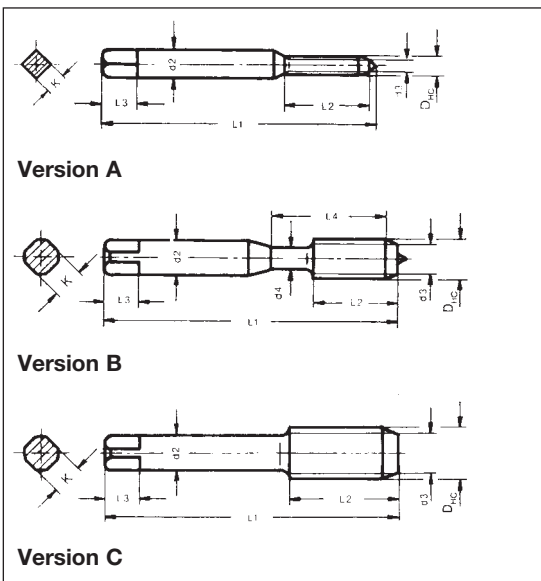

Nominal thread Ø	Taps for tolerance class 5H (6H mod.)*	Taps for tolerance class 5H (6H mod.)*	Taps for tolerance class 5H (6H mod.)*
	Type 0141.1 Item No	Type 0141.4 Item No	Type 0141.5 Item No
d			
M 2	0141 102 0104	0141 402 0152	0141 502 0102
M 2.5	0141 125 0104	0141 425 0152	0141 525 0102
M 3	0141 103 0104	0141 403 0152	0141 503 0102
M 3.5	0141 135 0104	0141 435 0152	0141 535 0102
M 4	0141 104 0104	0141 404 0152	0141 504 0102
M 5	0141 105 0104	0141 405 0152	0141 505 0102
M 6	0141 106 0104	0141 406 0152	0141 506 0102
M 7	0141 107 0104	0141 407 0152	0141 507 0102
M 8	0141 108 0104	0141 408 0152	0141 508 0102
M 8 x 1	0141 108 3104	0141 408 3152	0141 508 3102
M 9	0141 109 0104	0141 409 0152	0141 509 0102
M 10	0141 110 0104	0141 410 0152	0141 510 0102
M 10 x 1	0141 110 3104	0141 410 3152	0141 510 3102
M 10 x 1.25	0141 110 9104	–	0141 510 9102
M 11	0141 111 0104	0141 411 0152	0141 511 0102
M 12	0141 112 0104	0141 412 0152	0141 512 0102
M 12 x 1	0141 112 3104	0141 412 3152	0141 512 3102
M 12 x 1.25	0141 112 9104	–	0141 512 9102
M 12 x 1.5	0141 112 4104	0141 412 4152	0141 512 4102
M 14	0141 114 0104	–	0141 514 0102
M 14 x 1	0141 114 3104	0141 414 3152	0141 514 3102
M 14 x 1.25	0141 114 9104	–	–
M 14 x 1.5	0141 114 4104	0141 414 4152	0141 514 4102
M 16	0141 116 0104	–	0141 516 0102
M 16 x 1.5	0141 116 4104	0141 416 4152	0141 516 4102
M 18	0141 118 0104	–	0141 518 0102
M 18 x 1.5	0141 118 4104	0141 418 4152	0141 518 4102
M 18 x 2	0141 118 5104	–	0141 518 5102
M 20	0141 120 0104	–	0141 520 0102
M 20 x 1.5	0141 120 4104	0141 420 4152	0141 520 4102
M 20 x 2	0141 120 5104	–	0141 520 5102
M 22	0141 122 0104	–	0141 522 0102
M 22 x 1.5	0141 122 4104	0141 422 4152	0141 522 4102
M 22 x 2	0141 122 5104	–	0141 522 5102
M 24	0141 124 0104	–	0141 524 0102
M 24 x 1.5	0141 124 4104	0141 424 4152	0141 524 4102
M 24 x 2	0141 124 5104	–	0141 524 5102
M 26 x 1.5	0141 126 4104	0141 426 4152	0141 526 4102
M 27	0141 127 0104	–	0141 527 0102
M 27 x 1.5	0141 127 4104	0141 427 4152	0141 527 4102
M 27 x 2	0141 127 5104	–	0141 527 5102
M 28 x 1.5	0141 128 4104	0141 428 4152	0141 528 4102
M 30	0141 130 0104	–	0141 530 0102
M 30 x 1.5	0141 130 4104	0141 430 4152	0141 530 4102
M 30 x 2	0141 130 5104	–	0141 530 5102
M 33	0141 133 0104	–	0141 533 0102
M 33 x 2	0141 133 5104	–	0141 533 5102
M 36	0141 136 0104	–	0141 536 0102
M 36 x 1.5	0141 136 4104	0141 436 4152	–
M 36 x 2	0141 136 5104	–	0141 536 5102
M 36 x 3	0141 136 6104	–	0141 536 6102

HELICOIL® special taps for specific applications and materials, see page 31.

** 1 N/mm² equals 1 MPa

Version	Min. outside Ø D _{HC}	Shank Ø h 9 d 2	Chamfer Ø d 3	Total length L 1	Types 0141.1/0141.4 Max. thread length L 2	Type 0141.5 Max. thread length L 2	Square length L 3	Square H 12 K	L 4	d 4	Nominal thread Ø d
A	2.5	2.8	2	50	8	4	5	2.1	–	–	M 2
B	3.1	3.5	2.5	56	11	5	6	2.7	18	2.6	M 2.5
B	3.7	4	3	56	13	6	6	2.7	20	3.1	M 3
B	4.3	4.5	3.5	63	13	7	6	3.1	21	3.6	M 3.5
B	4.9	6	4	70	16	8	8	4.9	25	4.2	M 4
B	6.0	6	5	80	17	10	8	4.9	30	5.2	M 5
B	7.3	8	6	90	20	12	9	6.2	35	6.2	M 6
B	8.3	9	7	90	20	12	10	7	35	7.2	M 7
B	9.6	10	8	100	20	14	11	8	39	8.3	M 8
B	9.3	9	8	90	20	12	10	7	35	8.2	M 8 x 1
C	10.6	8	9	100	22	14	9	6.2	–	–	M 9
C	12.0	9	10	110	24/16	16	10	7	–	–	M 10
C	11.3	9	10	100	22	16	10	7	–	–	M 10 x 1
C	11.6	9	10	100	22	16	10	7	–	–	M 10 x 1.25
C	13.0	11	11	100	22/20	20	11	9	–	–	M 11
C	14.3	11	12	110	26/20	20	12	9	–	–	M 12
C	13.3	11	12	100	22/20	20	12	9	–	–	M 12 x 1
C	13.6	11	12	100	22/20	20	12	9	–	–	M 12 x 1.25
C	14.0	11	12	100	22/20	20	12	9	–	–	M 12 x 1.5
C	16.6	12	14	110	28/20	20	12	9	–	–	M 14
C	15.3	12	14	100	22/20	20	12	9	–	–	M 14 x 1
C	15.6	12	14	100	22/20	20	12	9	–	–	M 14 x 1.25
C	16.0	12	14	100	22/20	20	12	9	–	–	M 14 x 1.5
C	18.6	14	16	125	34/25	25	14	11	–	–	M 16
C	18.0	14	16	110	25	25	14	11	–	–	M 16 x 1.5
C	21.3	16	18	140	34/25	25	15	12	–	–	M 18
C	20.0	16	18	125	25	25	15	12	–	–	M 18 x 1.5
C	20.6	16	18	140	34	25	15	12	–	–	M 18 x 2
C	23.3	18	20	140	34/25	25	17	14.5	–	–	M 20
C	22.0	18	20	125	25	25	17	14.5	–	–	M 20 x 1.5
C	22.6	18	20	140	34	25	17	14.5	–	–	M 20 x 2
C	25.3	18	22	160	38/30	30	17	14.5	–	–	M 22
C	24.0	18	22	140	28	28	17	14.5	–	–	M 22 x 1.5
C	24.6	18	22	140	28	28	17	14.5	–	–	M 22 x 2
C	27.9	20	24	160	38/30	30	19	16	–	–	M 24
C	26.0	18	24	140	28	28	17	14.5	–	–	M 24 x 1.5
C	26.6	20	24	140	28	28	19	16	–	–	M 24 x 2
C	28.0	20	26	140	28	28	19	16	–	–	M 26 x 1.5
C	30.9	22	27	180	50	50	21	18	–	–	M 27
C	29.0	22	27	150	28	28	21	18	–	–	M 27 x 1.5
C	29.6	22	27	150	28	28	21	18	–	–	M 27 x 2
C	30.0	22	28	150	28	28	21	18	–	–	M 28 x 1.5
C	34.5	28	30	200	56	56	25	22	–	–	M 30
C	32.0	22	30	150	28	28	21	18	–	–	M 30 x 1.5
C	32.6	25	30	160	30	28	23	20	–	–	M 30 x 2
C	37.5	28	33	200	56	56	25	22	–	–	M 33
C	35.6	28	33	170	30	30	25	22	–	–	M 33 x 2
C	41.2	32	36	200	60	60	27	24	–	–	M 36
C	38.0	28	36	170	30	30	25	22	–	–	M 36 x 1.5
C	38.6	32	36	170	30	30	27	24	–	–	M 36 x 2
C	39.9	32	36	200	60	60	27	24	–	–	M 36 x 3

Further sizes on request.
 * For tolerance class 4H, the ninth digit of the item no changes from 1 to 2.
 For details see page 29.

Combined drilling and tapping tools



For tapping HELICOIL® tapped holes in damaged, stripped metric coarse and fine threads.

Pre-drilling of the HELICOIL® tapped holes tap hole is not required. Due to the $d \times L 5$ guiding unit, it can only be used for blind-hole threads under certain conditions.

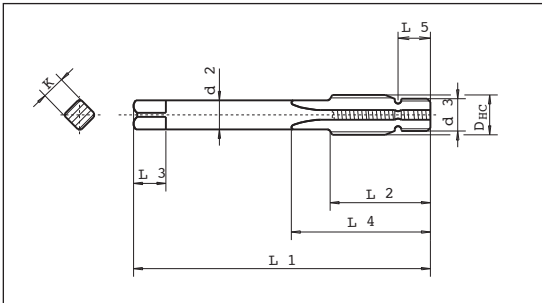

Nominal thread Ø	Item No
d	
M 6	0142 006 0102
M 8	0142 008 0102
M 10	0142 010 0102
M 10 x 1	0142 910 3450
M 12	0142 912 0450
M 12 x 1.25	0142 912 9450
M 12 x 1.5	0142 912 4450
M 14	0142 914 0450
M 14 x 1.25	0142 914 9450
M 14 x 1.25	0142 014 9102
M 14 x 1.5	0142 914 4450
M 16	0142 916 0450
M 16 x 1.5	0142 916 4450

Machine forming taps for **HELICOIL® Plus**



- Chipless production of internal threads for blind-hole and through-hole threads
- With oil grooves
- Perfect lubrication even for large depths
- Cutting speeds as for tapping

Lubrication:

Oil-containing lubricants or grease-containing emulsions.

Range of materials:

Very ductile materials, such as aluminium, copper or zinc alloys, steel with a strength up to 700 N/mm^2 *, soft stainless steels.

For materials with a minimum elongation at break of 10 %.

Nominal thread Ø	Guide value for shaped hole Ø d_F	Item No ①
d		
M 3	3.4	0144 103 0004
M 3.5	4.0	0144 135 0004
M 4	4.6	0144 104 0004
M 5	5.6	0144 105 0004
M 6	6.8	0144 106 0004
M 8	9.0	0144 108 0004
M 10	11.2	0144 110 0004
M 12	13.4	0144 112 0004

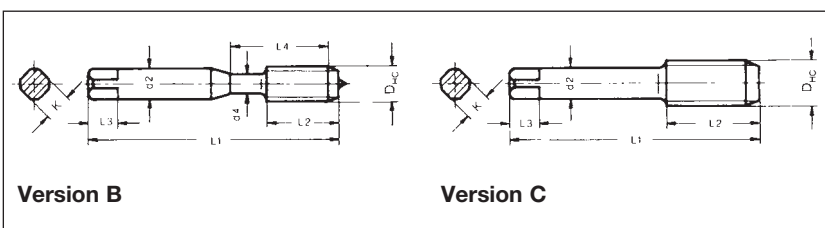

* 1 N/mm^2 equals 1 MPa

Min. outside Ø D _{HC}	Shank Ø h 9 d 2	Chamfer Ø d 3	Total length L 1	Max. thread length L 2	Square length L 3	L 4 min.	Guide thread length L 5	Square h 12 K	Nominal thread Ø d
7.3	8	M 6	90	26	9	36	6	6.2	M 6
9.7	10	M 8	90	28	11	38	7.5	8	M 8
12.0	12	M 10	100	31	12	42	9	9	M 10
11.3	9	M 10 x 1	92	31	10	42	9	7	M 10 x 1
14.3	11	M 12	92	35	12	43	10	9	M 12
13.7	11	M 12 x 1.25	92	35	12	43	10	9	M 12 x 1.25
13.7	11	M 12 x 1.25	92	35	12	43	10	9	M 12 x 1.5
13.7	11	M 12 x 1.25	92	35	12	43	10	9	M 14
15.7	11	M 14 x 1.25	92	35	12	43	10	9	M 14 x 1.25
15.7	11	M 14 x 1.25	153	35	12	43	10	9	M 14 x 1.25
16.0	11	M 14 x 1.5	92	35	12	43	10	9	M 14 x 1.5
18.7	14	M 16	90	39	14	50	9	11	M 16
18.0	14	M 16 x 1.5	92	39	14	50	10	11	M 16 x 1.5

Version	Min. outside Ø D _{HC}	Shank Ø h 9 d 2	Total length L 1	Max. thread length L 2	Square length L 3	Square h 12 K	L 4	d 4	Nominal thread Ø d
B	3.69	4	56	13	6	2.7	20	3.1	M 3
B	4.33	4.5	63	13	6	3.1	21	3.6	M 3.5
B	4.96	6	70	16	8	4.9	25	4.2	M 4
B	6.09	6	80	17	8	4.7	30	5.2	M 5
B	7.37	8	90	20	9	6.2	35	7.2	M 6
B	9.69	10	100	20	11	8	39	8.9	M 8
C	12.02	9	110	24	10	7	–	–	M 10
C	14.37	11	110	26	12	9	–	–	M 12

Further sizes on request.

We also offer TiN-coated forming taps.

① For tolerance class 4H, the ninth digit of the designation changes from 0 to 2.

For details see page 29.

Threaded plug gauges for **HELICOIL® Plus** holding threads

To check the trueness to gauge of holding threads produced with a HELICOIL® tap, we offer the following threaded plug gauges:



Nominal thread Ø	Thread pitch P	Tolerance class 6H mod or 5H Item No	Tolerance class 5H mod or 4H Item No
M 2	0.4	0147 302 0500	0147 302 0400
M 2.5	0.45	0147 325 0500	0147 325 0400
M 3	0.5	0147 303 0500	0147 303 0400
M 3.5	0.6	0147 335 0500	0147 335 0400
M 4	0.7	0147 304 0500	0147 304 0400
M 5	0.8	0147 305 0500	0147 305 0400
M 6	1	0147 306 0500	0147 306 0400
M 7	1	0147 307 0500	0147 307 0400
M 8	1.25	0147 308 0500	0147 308 0400
M 8 x 1	1	0147 308 3500	0147 308 3400
M 9	1.25	0147 309 0500	0147 309 0400
M 10	1.5	0147 310 0500	0147 310 0400
M 10 x 1	1	0147 310 3500	0147 310 3400
M 10 x 1.25	1.25	0147 310 9500	0147 310 9400
M 11	1.5	0147 311 0500	0147 311 0400
M 12	1.75	0147 312 0500	0147 312 0400
M 12 x 1	1	0147 312 3500	0147 312 3400
M 12 x 1.25	1.25	0147 312 9500	0147 312 9400
M 12 x 1.5	1.5	0147 312 4500	0147 312 4400
M 14	2	0147 314 0500	0147 314 0400
M 14 x 1	1	0147 314 3500	0147 314 3400
M 14 x 1.25	1.25	0147 314 9500	0147 314 9400
M 14 x 1.5	1.5	0147 314 4500	0147 314 4400
M 16	2	0147 316 0500	0147 316 0400
M 16 x 1.5	1.5	0147 316 4500	0147 316 4400
M 18	2.5	0147 318 0500	0147 318 0400
M 18 x 1.5	1.5	0147 318 4500	0147 318 4400
M 18 x 2	2	0147 318 5500	0147 318 5400
M 20	2.5	0147 320 0500	0147 320 0400
M 20 x 1.5	1.5	0147 320 4500	0147 320 4400
M 20 x 2	2	0147 320 5500	0147 320 5400
M 22	2.5	0147 322 0500	0147 322 0400
M 22 x 1.5	1.5	0147 322 4500	0147 322 4400
M 22 x 2	2	0147 322 5500	0147 322 5400
M 24	3	0147 324 0500	0147 324 0400
M 24 x 1.5	1.5	0147 324 4500	0147 324 4400
M 24 x 2	2	0147 324 5500	0147 324 5400
M 26 x 1.5	1.5	0147 326 4500	0147 326 4400
M 27	3	0147 327 0500	0147 327 0400
M 27 x 1.5	1.5	0147 327 4500	0147 327 4400
M 27 x 2	2	0147 327 5500	0147 327 5400
M 28 x 1.5	1.5	0147 328 4500	0147 328 4400
M 30	3.5	0147 330 0500	0147 330 0400
M 30 x 1.5	1.5	0147 330 4500	0147 330 4400
M 30 x 2	2	0147 330 5500	0147 330 5400
M 33	3.5	0147 333 0500	0147 333 0400
M 33 x 2	2	0147 333 5500	0147 333 5400
M 36	4	0147 336 0500	0147 336 0400
M 36 x 1.5	1.5	0147 336 4500	0147 336 4400
M 36 x 2	2	0147 336 5500	0147 336 5400
M 36 x 3	3	0147 336 6500	0147 336 6400

Further sizes on request.

Thread tolerances: For details see page 29.

A calibration certificate will be provided on request: item code 0147 999 9001

HELICOIL® Plus repair kits and repair range kits



Rejects recovery and thread repair

- Increased quality and value

HELICOIL® Plus repair kits M 2.5 – M 16

Repair kits contain:

- HELICOIL® Plus thread inserts of 3 lengths
- Twist drills (up to M 12)
- HSS manual tap
- Installation mandrel
- Tang break-off tool (up to M 12)

Special repair kits are available for repair of defective spark plug threads M 10 x 1 to M 14 x 1.25 as well as defective oil drain threads M 12 x 1.5 to M 16 x 1.5.

HELICOIL® Plus repair kits M 18 to M 36 x 1.5

Repair kits contain:

- HELICOIL® Plus thread inserts
- Manual tap
- Installation mandrel (M 18 to M 24 standard screw thread)
- Installation tool (M 27 to M 33 standard screw thread and M 18 x 1.5 to M 36 x 1.5 fine screw thread)

Special repair kits are available for e.g. repair of defective oxygen sensor threads M 18 x 1.5.

HELICOIL® Plus repair range kits

M 2.5 to M 6, M 4 to M 10, M 5 to M 12 and M 6 to M 14 x 1.25

Repair kits contain:

- HELICOIL® Plus thread inserts of different sizes and lengths
- Twist drills up to M 12 (for M 14 x 1.25 with combined drilling and tapping tool)
- HSS manual taps
- Installation mandrels
- Tang break-off tool

Special repair range kits are available for repair of defective spark plug threads M 10 x 1 to M 14 x 1.25 as well as defective oil drain threads M 12 x 1.5 x 9 to M 16 x 1.5 x 24.



For further demand we offer HELICOIL® Plus thread inserts in refill packs.
Order catalogue No 0180 or download at
www.boellhoff.de/en/thread-repair



System modules – the fastener	Page
Technology	05
Designs	06
A close look at the advantages	08
Modular system	10
Materials	12
Design guidelines	13
Fields of application	14
Installation	16
Technical data and item numbers	18
System modules – the tool	
The thread	28
Thread tolerances and tapped hole	29
All taps at a glance	30
Manual taps	32
Machine taps	34
Combined drilling and tapping tools	36
Machine forming taps	36
Threaded plug gauges	38
Repair kits and repair range kits	39
Installation	
Installation mandrels	42
Installation tools	
Battery installation tools	44
Electrical installation tools	45
Pneumatic installation tools	46
Accessories	52
Automatic installation	53
Manual installation tools	54
Tang break-off and extraction tools	55



HELICOIL® Plus installation mandrel

HELICOIL® Plus installation mandrels can be used with the following tools:

- Electrical installation tools type E-S 206 and E-S 410
- Battery installation tools type B-S 206 and B-S 824
- Pneumatic installation tools P-S 412 and P-S 1216

Your benefits

- Quick tool change
- Reduced tool costs
- Sizes M 2 to M 24
- Pick-and-place processing possible

Installation mandrel with depth stop

Only for installation of HELICOIL® Plus Free Running and Screwlock.
With external hexagon DIN 3126 – E 6.3/DIN ISO 1173.

For installation tools types B-S 206, E-S 206, E-S 410, P-S 412

Nominal thread \emptyset	Mandrel Free Running Item No	Mandrel Screwlock Item No	L ₁	L ₂ max.	L	D ₁	D ₂ \emptyset_{h9}	Design
M 2	4160 2302 020	4160 2302 022	25	9	100	8	8	1
M 2.5	4160 2325 020	4160 2325 022	25	9	100	8	8	1
M 3	4160 2303 020	4160 2303 022	30	14	100	8	8	1
M 3.5	4160 2335 020	4160 2335 022	30	14	100	8	8	1
M 4	4160 2304 020	4160 2304 022	35	16	100	8	8	1
M 5	4160 2305 020	4160 2305 022	40	20	105	10	8	1
M 6	4160 2306 020	4160 2306 022	40	20	105	11	8	1

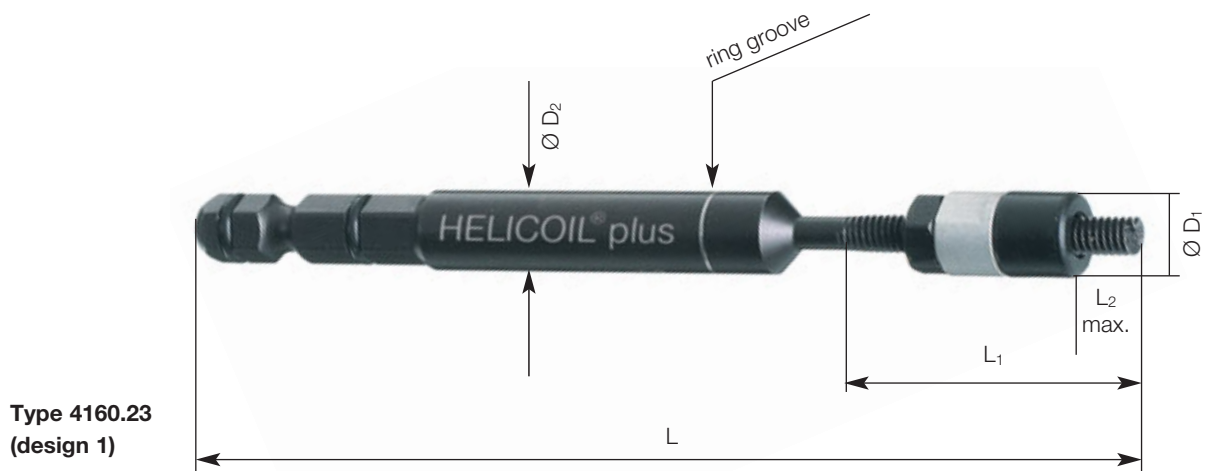

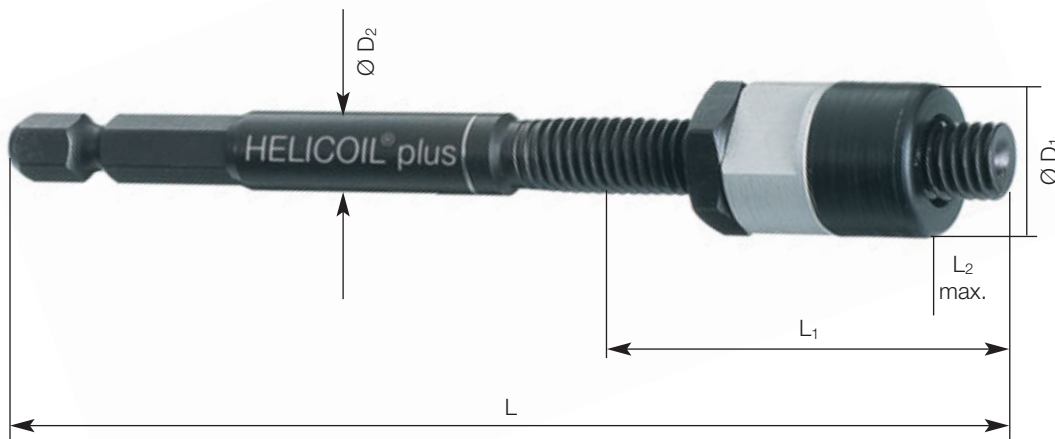

**Type
4160.25**

For installation tools types B-S 824, E-S 410, P-S 412 and P-S 1216

Nominal thread Ø	Mandrel Free Running Item No	Mandrel Screwlock Item No	L ₁	L ₂ max.	L	D ₁	D ₂ Ø _{h9}	Design
M 7	4160 2507 020	4160 2507 022	55	30	105	13	8	2
M 8	4160 2508 020	4160 2508 022	55	30	105	15	8	2
M 9	4160 2509 020	4160 2509 022	65	40	110	15	8	2
M 10	4160 2510 020	4160 2510 022	60	40	110	16	8	2
M 12	4160 2512 020	4160 2512 022	70	45	115	20	8	2
M 12 x 1.5	4160 2512 420	4160 2512 422	65	45	115	20	8	2
M 14	4160 2514 020	4160 2514 022	70	50	120	21	8	2
M 14 x 1.5	4160 2514 420	4160 2514 422	70	50	120	21	8	2
M 16	4160 2516 020	4160 2516 022	80	55	135	24	8	2
M 16 x 1.5	4160 2516 420	4160 2516 422	80	55	135	24	8	2
M 18	4160 2518 020	4160 2518 022	90	65	135	30	8	2
M 20	4160 2520 020	4160 2520 022	100	70	145	31	8	2
M 22	4160 2522 020	4160 2522 022	110	80	155	33	8	2
M 24	4160 2524 020	4160 2524 022	120	90	165	35	8	2

Adapted tools for inserts of Inconel X 750, Nimonic 90 and aluminium on request.



These installation mandrels can also be used as manual installation mandrels.

HELICOIL® Plus Screwlock installation mandrels are marked with a ring groove on the guide shaft. HELICOIL® Free Running installation mandrels have a smooth guide shaft.

Installation tools for **HELICOIL® Plus**

Basically, there are three types of installation tools. Installation tools are chosen based on the volume of HELICOIL® Plus thread inserts to process, the location of the tapped holes in the workpiece and the thread size.

Hence, there are:

- Manual installation tools
- Electrical installation tools
- Electrical installation tools with battery power
- Pneumatic installation tools

Battery installation tools



Battery power pack installation tool type B-S 206

For processing HELICOIL® Plus M 2 to M 6 with HELICOIL® Plus installation mandrel

Delivery scope:

- Battery gun-straight installation tool (articulated)
- 2 pieces battery pack 3.6 V; 1.5 Ah
- Quick charger
- Case

Technical data:

Idle speed:	Two-speed 200 rpm and 600 rpm, reversible
Torque:	Adjustable in 21 steps 0.3–2.9 Nm/4.4 Nm max.
Tool holder:	1/4" hexagon socket
Weight incl. battery:	0.5 kg
Battery:	3.6 V/1.5 Ah/charging time 30 min
Item No:	4160 430 0000

Spare parts and accessories:

Spare battery:	Item No 4160 430 0200
Quick charger:	Item No 4160 430 0300



Battery power pack installation tool type B-S 824

For processing HELICOIL® Plus M 7 to M 24 with HELICOIL® Plus installation mandrel

Delivery scope:

- Battery gun screwdriver
- 2 pieces battery pack 15.6 V; 3 Ah
- Quick charger
- Case

Technical data:

Idle speed:	Speed 1/stepless 65– 450 rpm, reversible Speed 2/stepless 200–1450 rpm, reversible
Torque:	19-step adjustable 1–6.9 Nm/31.9 Nm max.
Tool holder:	Three-jaw chuck 1.0–13 mm
Weight incl. battery:	2.0 kg
Battery:	15.6 V/3 Ah/charging time 45 min
Item No:	4160 350 0000

Spare parts and accessories:

Spare battery:	Item No 4160 350 0200
Quick charger:	Item No 4160 350 0300

Electrical installation tools



Type E-S 206

For quick processing of HELICOIL® Plus thread inserts M 2 to M 6 with HELICOIL® Plus installation mandrel

Delivery scope:

- Straight screwdriver with 1/4" hexagon
- Power supply for two screwdrivers
- Case

Technical data:

Idle speed: 720 rpm
 Output voltage: 35 V DC
 Torque: M = 0.45 – 0.95 Nm
 Steplessly adjustable shut-off clutch
 Tool holder: 1/4" hexagon socket with radial bearing
 Weight: 0.31 kg
 Item No: **4160 220 0000**

The installation mandrels for all available sizes are provided on page 42/43.



Type E-S 410

For quick processing of HELICOIL® Plus thread inserts M 4 to M 10 with HELICOIL® Plus installation mandrel

Delivery scope:

- Straight screwdriver with quick-change chuck 1/4" hexagon socket
- Speed control with ramp control on control device EDU 2AE
- Case

Technical data:

Idle speed: 1200 rpm (steplessly adjustable)
 Automatic change-over of the direction of rotation when reaching the screw-in depth
 Torque: 0.9 to 3 Nm
 Torque steplessly adjustable on the control device
 Tool holder: Quick-change chuck 1/4" hexagon socket with radial bearing for installation mandrel
 Weight: 0.57 kg
 Item No: **4160 540 0000**

The installation mandrels for all available sizes are provided on page 42/43.



Type E-PSG 256 with leader cartridge

For quick processing of HELICOIL® Plus thread inserts M 2.5 to M 6 with HELICOIL® Plus exchange unit

Delivery scope: See type E-S 410

Technical data:

Idle speed: 1200 rpm (steplessly adjustable)
 Automatic change-over of the direction of rotation when reaching the screw-in depth
 Torque: 0.9 to 3 Nm
 Torque steplessly adjustable on the control device
 Tool holder: Connection for leader cartridges of P-PSG 256
 Weight: 0.75 kg
 Item No: **0160 470 0000**

The exchange units for all available sizes are provided on pages 49 and 51.

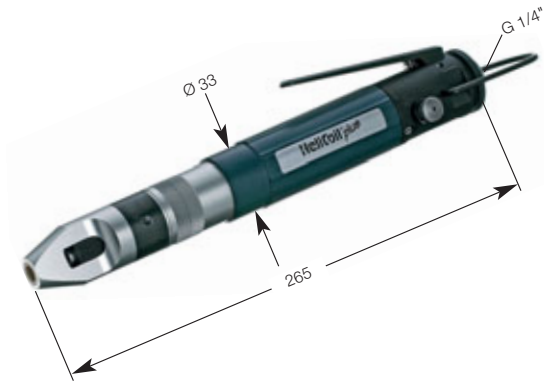

Pneumatic installation tool type P-S 412

For quick processing of HELICOIL® Plus M 4 to M 12 with HELICOIL® Plus installation mandrel

Technical data:

Idle speed:	1500 rpm at p = 6.3 bar Adjustable through air pressure
Air consumption:	5.5 l/s at p = 6.3 bar
Torque:	M = 1.2–4.5 Nm Steplessly adjustable shut-off clutch
Tool holder:	1/4" hexagon socket with radial bearing
Weight:	0.8 kg
Item No:	4160 270 0010

HELICOIL® Plus installation mandrels depending on the size with depth stop must be ordered separately, see page 42/43.

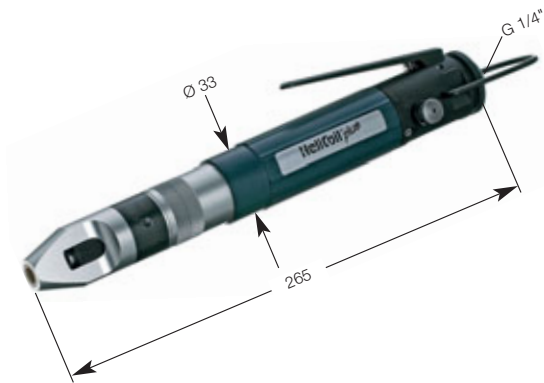

Pneumatic installation tool type P-S 1216

For quick processing of HELICOIL® Plus M 12 to M 16 with HELICOIL® Plus installation mandrel

Technical data:

Idle speed:	950 rpm at p = 6.3 bar Adjustable through air pressure
Air consumption:	5.5 l/s at p = 6.3 bar
Torque:	M = 1.2–5.5 Nm Steplessly adjustable shut-off clutch
Tool holder:	1/4" hexagon socket with radial bearing
Weight:	0.8 kg
Item No:	4160 180 0010

HELICOIL® Plus installation mandrels depending on the size with depth stop must be ordered separately, see page 42/43.

**Spare handle for P-S 1216**

Handle for safe compensation of installation torque for sizes \geq M 12
Item No: **4160 180 0006**

**Suspension bracket for P-S 412 and P-S 1216**

For horizontal suspension of tools on counterbalance systems
Item No: **4160 180 0007**

For **HELICOIL®** Classic and **HELICOIL®** Plus Free Running and Screwlock

Pitch-controlled **HELICOIL®** Classic and **HELICOIL®** Plus installation tool for **bulk material processing**.

The installation tool is equipped with a reversible compressed-air motor and a size-dependent exchange unit.

The **HELICOIL®** installation depth is adjusted with compensation washers.

We recommend this tool for medium and large scale production.

Complete tool

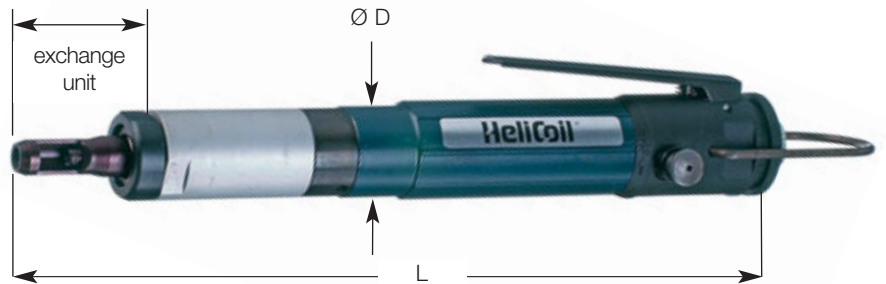

Type***	Nominal thread Ø d	Complete tool Item No	Dimensions		Weight kg	Connec-tion bar	**Air consumption l/min.
			Ø D	L			
P-PSG 256	M 2.5	0160 372 5000	28	240	0.6	2.5–4.0	204
	M 3	0160 370 3000	28	240	0.6	2.5–4.0	204
	M 4	0160 370 4000	28	240	0.6	2.5–4.0	204
	M 5	0160 370 5000	28	240	0.6	2.5–4.0	204
	M 6	0160 370 6000	28	240	0.6	2.5–4.0	204
P-PSG 714	M 7	0160 280 7000	42	360	1.4	4.0–5.0	282
	M 8	0160 280 8000	42	360	1.4	4.0–5.0	282
	M 8 x 1	0160 280 8300	42	360	1.4	4.0–5.0	282
	M 10	0160 281 0000	42	360	1.4	4.0–5.0	282
	M 10 x 1.25	0160 281 0900	42	360	1.4	4.0–5.0	282
	M 10 x 1	0160 281 0300	42	360	1.4	4.0–5.0	282
	M 12	0160 281 2000	42	360	1.4	4.0–5.0	282
	M 12 x 1.5	0160 281 2400	42	360	1.4	4.0–5.0	282
	M 12 x 1.25	0160 281 2900	42	360	1.4	4.0–5.0	282
	M 12 x 1	0160 281 2300	42	360	1.4	4.0–5.0	282
	M 14*	0160 281 4000	42	360	1.4	4.0–5.0	282
	M 14 x 1.5	0160 281 4400	42	360	1.4	4.0–5.0	282
M 14 x 1.25	0160 281 4900	42	360	1.4	4.0–5.0	282	
P-PSG 1626	M 16	0160 191 6000	42	440	2.5	4.0–6.0	282
	M 16 x 1.5	0160 191 6400	42	440	2.5	4.0–6.0	282
	M 18 x 1.5	0160 191 8400	42	440	2.5	4.0–6.0	282
	M 20	0160 192 0000	42	440	2.5	4.0–6.0	282
	M 20 x 1.5	0160 192 0400	42	440	2.5	4.0–6.0	282
	M 22 x 1.5	0160 192 2400	42	440	2.5	4.0–6.0	282
	M 24 x 1.5*	0160 192 4400	42	440	2.5	4.0–6.0	282
M 26 x 1.5*	0160 192 6400	42	440	2.5	4.0–6.0	282	

Important order information:

When you order tools, specify type, size and length of **HELICOIL®** Plus thread inserts to process. Tools for installation of **HELICOIL®** Plus thread inserts with lengths > 2.5 d on request. As required by German accident prevention regulations (UVV), types P-PSG 714 and P-PSG 1626 are equipped with a sliding sleeve as finger guard.

This finger guard must not be removed.

Installation tools are equipped with Bosch motors.

*Basic tool with stronger motor.

**Air consumption at 6.3 bar. (See page 46.)

***Exchange units can be interchanged within the individual series.

Adapted tools for inserts of Inconel X 750, Nimonic 90 and aluminium on request.

Subassemblies

Exchange unit



Basic tool



Motor



Type***	Nominal thread Ø	Exchange unit	Basic tool	Motor
	d	Item No	Item No	Item No
P-PSG 256	M 3	0160 270 3050	0160 370 0040	0160 370 0010
	M 4	0160 270 4050		
	M 5	0160 270 5050		
	M 6	0160 270 6050		
P-PSG 714	M 7	0160 280 7050	0160 180 0040	0160 180 0010
	M 8	0160 280 8050		
	M 8 x 1	0160 281 8350		
	M 10	0160 281 0050		
	M 10 x 1.25	0160 281 0950		
	M 10 x 1	0160 281 0350		
	M 12	0160 281 2050		
	M 12 x 1.5	0160 281 2450		
	M 12 x 1.25	0160 281 2950		
	M 12 x 1	0160 281 2350		
	M 14*	0160 281 4050		0160 090 0011
M 14 x 1.5	0160 281 4450	0160 180 0010		
M 14 x 1.25	0160 281 4950			
P-PSG 1626	M 16	0160 191 6050	0160 090 0040	0160 090 0011
	M 16 x 1.5	0160 191 6450		
	M 18 x 1.5	0160 191 8450		
	M 20	0160 192 0050		
	M 20 x 1.5	0160 192 0450		
	M 22 x 1.5	0160 192 2450		
	M 24 x 1.5*	0160 192 4450		
M 26 x 1.5*	0160 192 6450			

Wear and spare parts

Prewinder



Installation mandrel



Clutch for installation mandrel



Range of compensation washers



Type***	Nominal thread Ø	Prewinder	Installation mandrel	Clutch for installation mandrel	Range of compensation washers
	d	Item No	Item No	Item No	Item No
P-PSG 256	M 2.5	0160 172 5032	0160 372 5020	0160 170 0006	0160 170 0060
	M 3	0160 170 3032	0160 270 3020		
	M 4	0160 170 4032	0160 270 4020		
	M 5	0160 170 5032	0160 270 5020		
	M 6	0160 170 6032	0160 270 6020		
P-PSG 714	M 7	0160 280 7032	0160 280 7020	0160 180 0006	0160 280 0060
	M 8	0160 280 8032	0160 280 8020		
	M 8 x 1	0160 280 8332	0160 280 8320		
	M 10	0160 281 0032	0160 281 0020		
	M 10 x 1.25	0160 281 0932	0160 281 0920		
	M 10 x 1	0160 281 0332	0160 281 0320		
	M 12	0160 281 2032	0160 281 2020		
	M 12 x 1.5	0160 281 2432	0160 281 2420		
	M 12 x 1.25	0160 281 2932	0160 281 2920		
	M 12 x 1	0160 281 2332	0160 281 2320		
	M 14*	0160 281 4032	0160 281 4020		
M 14 x 1.5	0160 281 4432	0160 281 4420			
M 14 x 1.25	0160 281 4932	0160 281 4920			
P-PSG 1626	M 16	0160 191 6032	0160 191 6020	0160 090 0006	0160 190 0060
	M 16 x 1.5	0160 191 6432	0160 191 6420		
	M 18 x 1.5	0160 191 8432	0160 191 8420		
	M 20	0160 192 0032	0160 192 0020		
	M 20 x 1.5	0160 192 0432	0160 192 0420		
	M 22 x 1.5	0160 192 2432	0160 192 2420		
	M 24 x 1.5*	0160 192 4432	0160 192 4420		
M 26 x 1.5*	0160 192 6432	0160 192 6420			

Exemplary illustrations.

For HELICOIL® Classic STRIPFEED® and HELICOIL® Plus STRIPFEED®

Pitch-controlled HELICOIL® Classic and HELICOIL® Plus installation tool for processing **magazined thread inserts**.

The installation tool is equipped with a reversible compressed-air motor and a size-dependent exchange unit.

The HELICOIL® installation depth is adjusted with compensation washers.

We recommend this tool for medium and large scale production.

Complete tool

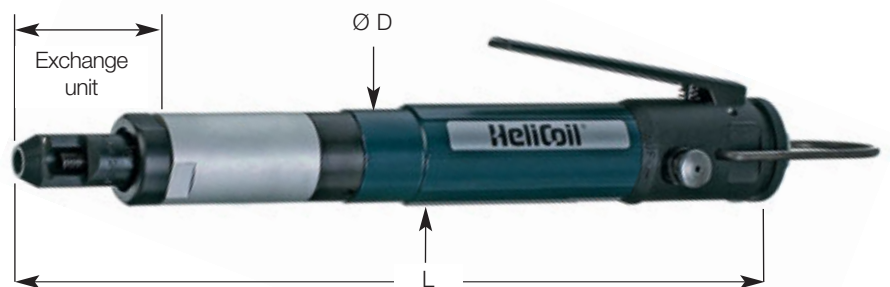

Type**	Nominal thread Ø d	Complete tool Item No	Max. length	Dimensions		Weight kg	Connec-tion bar	*Air consumption l/min.
				Ø D	L			
P-PSG 256 SF	M 2.5	0160 372 5002	≤ 1.25 d	28	240	0.6	2.5–4.0	204
	M 2.5	0160 372 5003	1.5–2.5 d	28	240	0.6	2.5–4.0	204
	M 3	0160 370 3002	≤ 1.25 d	28	240	0.6	2.5–4.0	204
	M 3	0160 370 3003	1.5–2.5 d	28	240	0.6	2.5–4.0	204
	M 4	0160 370 4002	≤ 1.25 d	28	240	0.6	2.5–4.0	204
	M 4	0160 370 4003	1.5–2.5 d	28	240	0.6	2.5–4.0	204
	M 5	0160 370 5002	≤ 1.25 d	28	240	0.6	2.5–4.0	204
	M 5	0160 370 5003	1.5–2.5 d	28	240	0.6	2.5–4.0	204
	M 6	0160 370 6002	≤ 1.25 d	28	240	0.6	2.5–4.0	204
M 6	0160 370 6003	1.5–2.5 d	28	240	0.6	2.5–4.0	204	
P-PSG 714 SF	M 7	0160 280 7002	≤ 1.25 d	42	360	1.4	4.0–5.0	282
	M 7	0160 280 7003	1.5–2.5 d	42	360	1.4	4.0–5.0	282
	M 8	0160 280 8002	≤ 1.25 d	42	360	1.4	4.0–5.0	282
	M 8	0160 280 8003	1.5–2.5 d	42	360	1.4	4.0–5.0	282
	M 10	0160 281 0002	≤ 1.25 d	42	360	1.4	4.0–5.0	282
	M 10	0160 281 0003	1.5–2.5 d	42	360	1.4	4.0–5.0	282

Important order information:

When you order tools, specify type, size and length of HELICOIL® Plus thread inserts to process. Tools for installation of HELICOIL® Plus thread inserts with lengths > 2.5 d on request. Installation tools are equipped with Bosch motors.

*Air consumption at 6.3 bar.

**Exchange units can be interchanged within the individual series.

Adapted tools for inserts of Inconel X 750, Nimonic 90 and aluminium on request.

Exchange unit



Basic tool



Motor



Subassemblies

Type**	Nominal thread Ø	Exchange unit ≤ 1.25 d	Exchange unit 1.5–2 d	Basic tool	Motor
	d	Item No	Item No	Item No	Item No
P-PSG 256 SF	M 2.5	0160 272 5052	0160 272 5053	0160 370 0040	0160 370 0010
	M 3	0160 270 3052	0160 270 3053		
	M 4	0160 270 4052	0160 270 4053		
	M 5	0160 270 5052	0160 270 5053		
	M 6	0160 270 6052	0160 270 6053		
P-PSG 714 SF	M 7	0160 280 7052	0160 280 7053	0160 180 0040	0160 180 0010
	M 8	0160 280 8052	0160 280 8053		
	M 10	0160 281 0052	0160 281 0053		

Prewinder



Installation mandrel



Clutch for installation mandrel



Wear and spare parts

Type**	Nominal thread Ø	Prewinder ≤ 1.25 d	Prewinder 1.5–2.5 d	Installation mandrel	Clutch for installation mandrel
	d	Item No	Item No	Item No	Item No
P-PSG 256 SF	M 2.5	0160 172 5035	0160 172 5033	0160 272 5020	0160 170 0006
	M 3	0160 170 3035	0160 170 3034	0160 270 3020	
	M 4	0160 170 4035	0160 170 4033	0160 270 4020	
	M 5	0160 170 5035	0160 170 5033	0160 270 5020	
	M 6	0160 170 6035	0160 170 6033	0160 270 6020	
P-PSG 714 SF	M 7	0160 180 7035	0160 180 7033	0160 280 7020	0160 180 0006
	M 8	0160 180 8035	0160 180 8033	0160 280 8020	
	M 10	0160 181 0035	0160 181 0033	0160 281 0020	

Range of compensation washers ≤ M 6: Item No 0160 170 0060, ≥ M 8: 0160 280 0060.

Range of compensation washers



Exemplary illustrations.



Parallel system type S for HELICOIL® Classic and HELICOIL® Plus installation tools

Type	Product characteristics		Item No
S 600	Work radius	130 mm–450 mm	0182 080 0003 (see delivery scope)
	Work height	50 mm–450 mm	
	Weight without tool	8 kg	
	Torque absorption	15 Nm max.	

Advantages

- Rationalisation
- Quick and positioning especially for small dimensions
- Easy handling, no operator fatigue
- No return rotation forces
- Absorption of screwdriver weight
- Can be used with electrical and pneumatic HELICOIL® installation tools
- Quick tool change
- 360° rotatable
- Smooth and precise roller guides
- Optimum workstation layout

Delivery scope

- 3-axis guiding system
- Tool holder
- 1 counterbalance 1–3 kg
- Base plate made of extruded aluminium profile with grooves, dimensions w x h x l: 240 x 40 x 500 mm

Accessories

Type	Size	Item No
Service unit	at 6 bar nominal flow G01" = 700l/min	0182 080 1001
Stationary roller holder for HELICOIL® Plus STRIPFEED®		0182 080 0004
Hose	ID 6	0196 000 1130
Hose clip	8–12 mm	0196 000 1150
Hose tail	G 1/8" -6	0196 000 1151
Hose tail	G 1/4" -6	0196 000 1152
Exhaust air hose	Ø 15 mm	0196 000 1131



Drill chuck with external hexagon

DIN 3126 – E 6.3 for type B-S 206
Item No 4160 000 0100

HELICOIL® Plus automatic installation

The economical installation of HELICOIL® Plus thread inserts is just as important as the high quality standard.

That is why we offer modules for integration into automatic processes as well as complete systems.

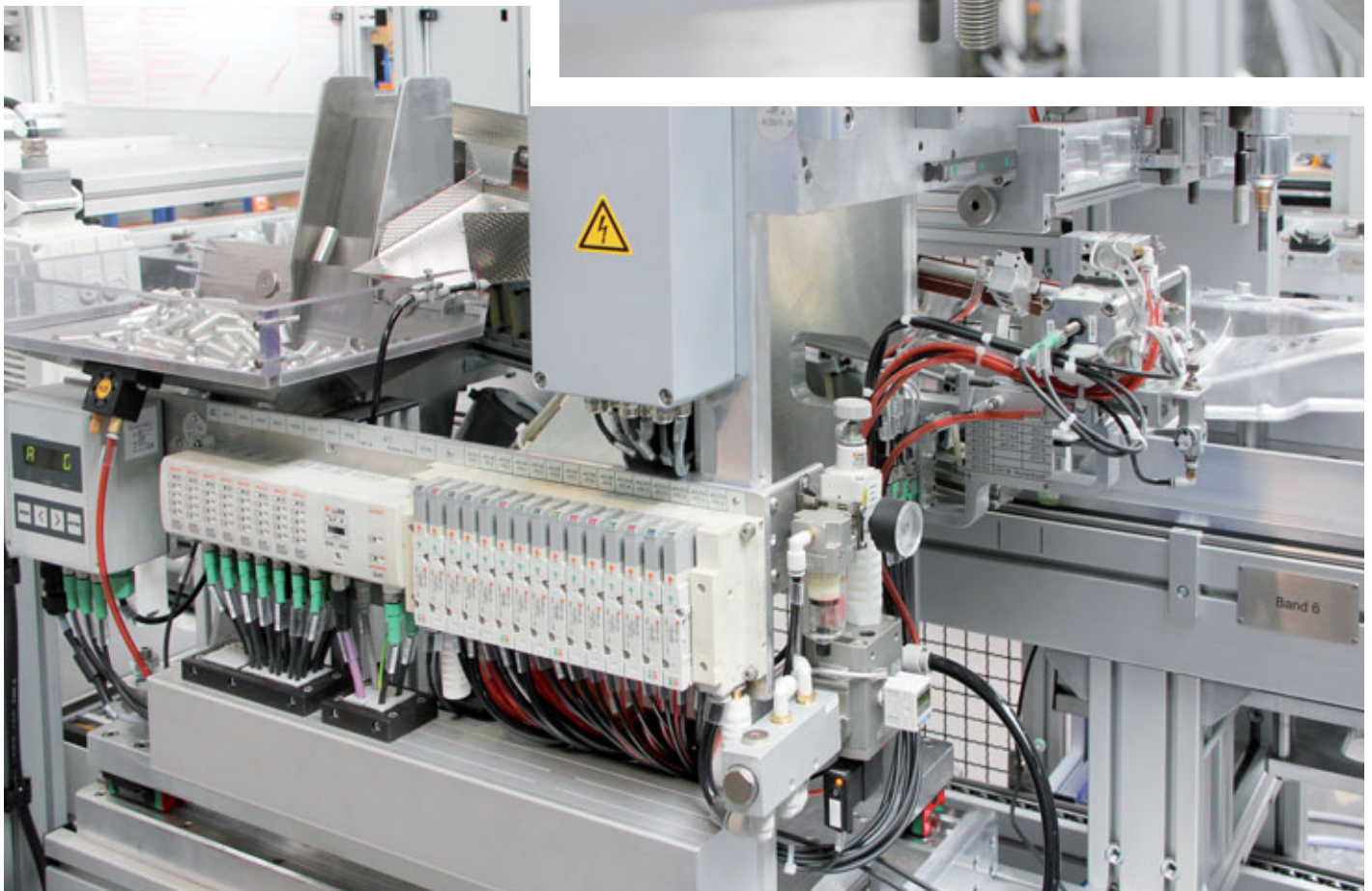

Manual installation tool with prewinder for HELICOIL® Classic and HELICOIL® Plus

Only required for HELICOIL® Plus for fine screw threads and special applications. Manual installation mandrels are described on page 42 (HELICOIL® Plus installation mandrels).

Nominal thread Ø	Type	Installation tool with prewinder Item No	Fly-over tool Type H-M Item No
M 2	H-PSG	0150 010 2000	–
M 2.5	H-PSG	0150 012 5000	–
M 3	H-PSG	0150 010 3000	–
M 3.5	H-PSG	0150 013 5000	–
M 4	H-PSG	0150 010 4000	–
M 5	H-PSG	0150 010 5000	–
M 6	H-PSG	0150 010 6000	–
M 7	H-PSG	0150 010 7000	–
M 8	H-PSG	0150 010 8000	–
M 8 x 1	H-PSG	0150 010 8300	–
M 9	H-PSG	0150 010 9000	–
M 10	H-PSG	0150 011 0000	–
M 10 x 1	H-PSG	0150 011 0300	–
M 10 x 1.25	H-PSG	0150 011 0900	–
M 11	H-PSG	0150 011 1000	–
M 12	H-PSG	0150 011 2000	–
M 12 x 1	H-PSG	0150 011 2300	–
M 12 x 1.25	H-PSG	0150 011 2900	–
M 12 x 1.5	H-PSG	0150 011 2400	–
M 14	H-PSG	0150 011 4000	–
M 14 x 1	H-PSG	0150 011 4300	–
M 14 x 1.25	H-PSG	0150 011 4900	–
M 14 x 1.5	H-PSG	0150 011 4400	–
M 16	H-PSG	0150 011 6000	–
M 16 x 1.5	H-PSG	0150 011 6400	–
M 18	H-M	–	0150 071 8000
M 18 x 1.5	H-PSG	0150 011 8400	–
M 18 x 2	H-PSG	0150 011 8500	–
M 20	H-M	–	0150 072 0000
M 20 x 1.5	H-PSG	0150 012 0400	–
M 20 x 2	H-PSG	0150 012 0500	–
M 22	H-M	–	0150 072 2000
M 22 x 1.5	H-PSG	0150 012 2400	–
M 22 x 2	H-PSG	0150 012 2500	–
M 24	H-M	–	0150 072 4000
M 24 x 1.5	H-PSG	0150 012 4400	–
M 24 x 2	H-PSG	0150 012 4500	–
M 26 x 1.5	H-PSG	0150 012 6400	–
M 27	H-M	–	0150 072 7000
M 27 x 1.5	H-PSG	0150 012 7400	–
M 27 x 2	H-PSG	0150 012 7500	–
M 28 x 1.5	H-PSG	0150 012 8400	–
M 30	H-M	–	0150 073 0000
M 30 x 1.5	H-PSG	0150 013 0400	–
M 30 x 2	H-PSG	0150 013 0500	–
M 33	H-M	–	0150 073 3000
M 33 x 2	H-PSG	0150 013 3500	–
M 36	H-M	–	0150 073 6000
M 36 x 1.5	H-PSG	0150 013 6400	–
M 36 x 2	H-PSG	0150 013 6500	–
M 36 x 3	H-PSG	0150 013 6600	–



Type **H-PSG**:
Threaded mandrel, pitch-controlled,
with depth stop
Item No 0150 01. ...*



Fly-over tool for HELICOIL® and HELICOIL® Plus
Type **H-M**
with depth stop
Item No 0150 07. ...*



Type **H-PMG**:
Plain mandrel, pitch-controlled,
with depth stop
on request



Type **H-PM**:
Plain mandrel, without pitch control,
with depth stop
on request

*Adapted tools for thread inserts of Inconel X 750, Nimonic 90 and aluminium on request.

Tang break-off and extraction tools for **HELICOIL®**

Tang break-off tools for **HELICOIL® Plus**



Tang break-off mandrel



Mechanical tang break-off tool with spring tension **type TB-M**



Pneumatic tang break-off tool with thrust trigger **type TB-P**

Nominal thread Ø	Tang break-off mandrel Item No	Type TB-M Item No	Type TB-P pneumatic system* Item No
M 2	0158 040 0000	0158 602 0000	–
M 2.5	0158 040 1000	0158 625 0000	–
M 3	0158 040 1000	0158 603 0000	0168 040 3000
M 3.5	0158 040 2000	0158 635 0000	–
M 4	0158 040 2000	0158 604 0000	0168 040 4000
M 5	0158 040 3000	0158 605 0000	0168 040 5000
M 6	0158 040 3000	0158 606 0000	0168 040 6000
M 7	0158 040 4000	0158 607 0000	0168 040 7000
M 8	0158 040 4000	0158 608 0000	0168 040 8000
M 9	0158 040 4000	0158 609 0000	–
M 10	0158 040 5000	0158 610 0000	0168 041 0000
M 11	0158 040 5000	0158 610 0000	–
M 12	0158 040 6000	0158 612 0000	0168 041 2000

* Operating pressure 3–4 bar, connection G 1/4".
From M 14, the tang must be removed with long nose pliers.



HELICOIL® extraction tool M 3 to M 5

HELICOIL® extraction tool

For manual and machine disassembly of HELICOIL® thread inserts M 3 to M 14 (larger sizes on request).

Delivery scope:

- Extracted tool
- Adapter for 1/4" hexagon
- Operating instructions
- Telescoping sleeve

Deep-installed HELICOIL® thread inserts can be extracted without damaging the parent thread:

	Steel	Aluminium R _m > 200 N/mm ² **	Aluminium R _m < 200 N/mm ² **
Flush-mounted HELICOIL®	OK	OK	OK
Deep-mounted HELICOIL®	OK	OK	limited



HELICOIL® extraction tool M 6 to M 56

Nominal thread Ø	Item No
M 3	0180 603 0000
M 4	0180 604 0000
M 5	0180 605 0000
M 6	0180 606 0000
M 8	0180 608 0000
M 10	0180 610 0000
M 12	0180 612 0000
M 14	0180 614 0000

From M 16 on request

The tool can be assembled using a tap wrench, ratchet or cordless screwdriver. The tool comes complete with an adapter for a cordless screwdriver.

** 1 N/mm² equals 1 MPa

Böllhoff International with companies in:

Argentina
Austria
Brazil
Canada
China
Czech Republic
France
Germany
Hungary
India
Italy
Japan
Korea
Mexico
Poland
Romania
Russia
Slovakia
Spain
Switzerland
Turkey
United Kingdom
USA

Apart from these 23 countries, Böllhoff supports its international customers in other important industrial markets in close partnership with agents and dealers.

KEL Bulgaria Ltd.
Please find your local contact on www.kelbulgaria.com
or contact us under info@kelbulgaria.com
Telephone: +359 877008832
Fax: +359 24922552

