



RIPP LOCK® screw lock

Efficient and secure

Kel
BULGARIA

BÖLLHOFF

RIPP LOCK® lock washers

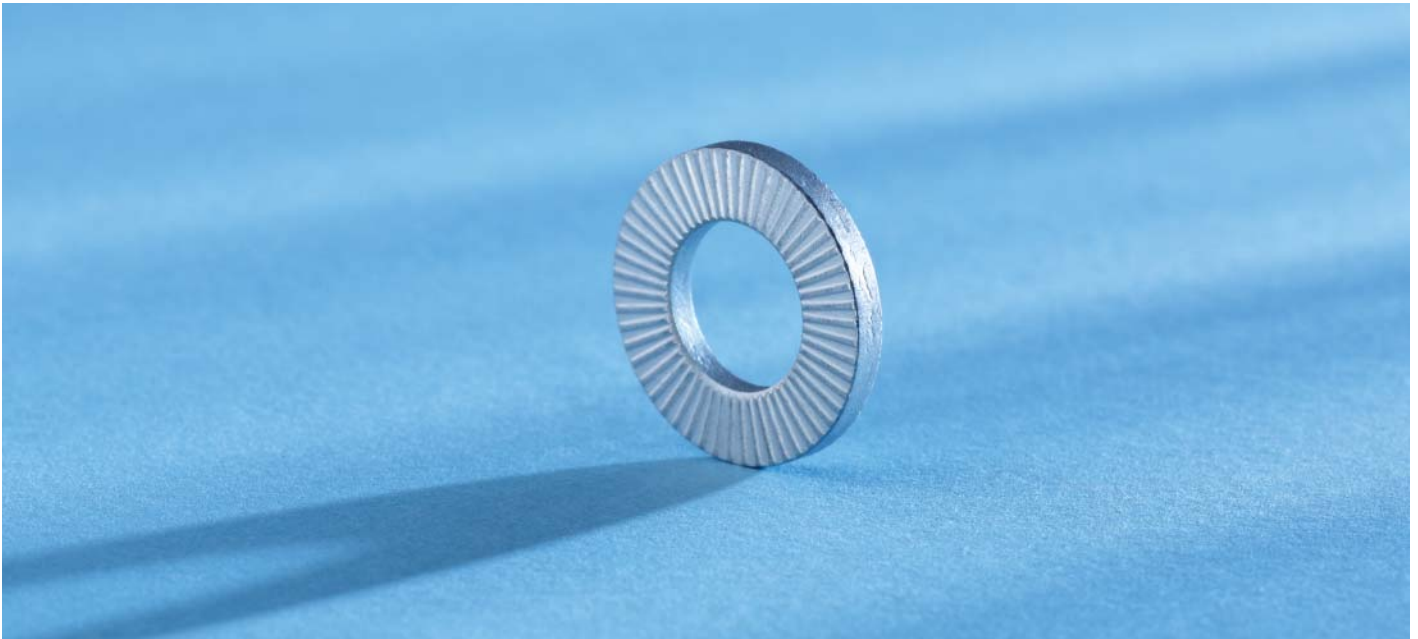

The system

RIPP LOCK® lock washers have radial ribs on both sides.

The contact angle at the foot of the ribs is obvious larger than the gradient angle of the metric thread.

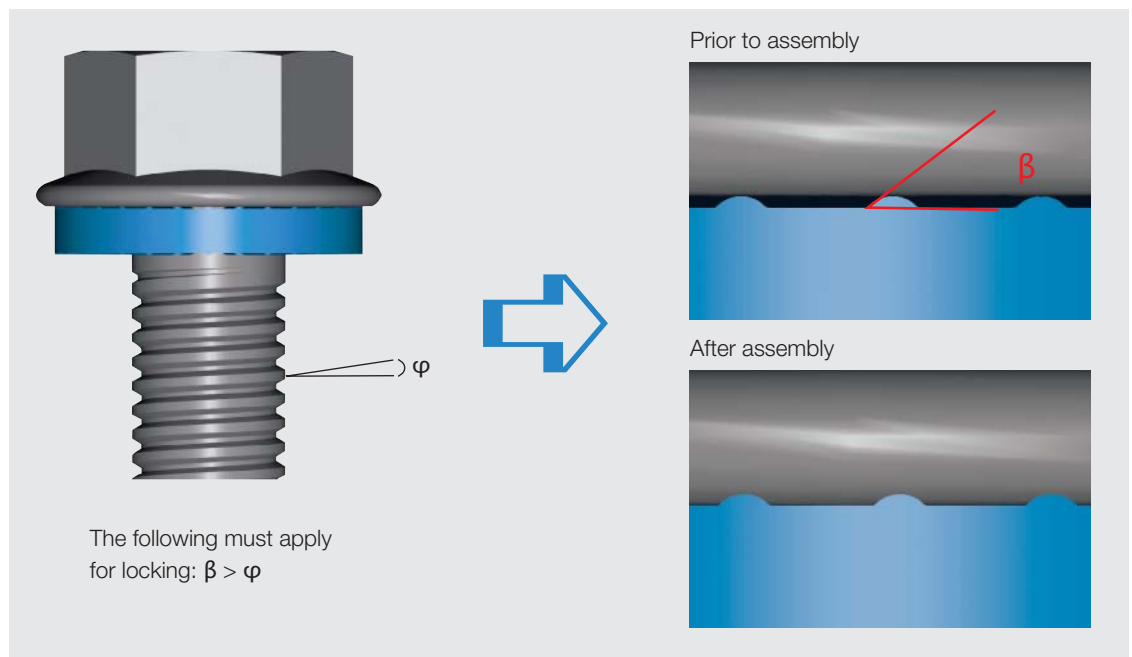

RIPP LOCK® lock washers

Benefits



Because of the preload force the ribs of the RIPP LOCK® washers are embossed into the counter surface during assembly. The resulting form lock prevents self-loosening of the connection reliably, even under extreme vibrations or high dynamic stresses. Due to their high hardness the washers can be used with screws of all property classes up to 12.9.

Excellent locking against self-unscrewing – even under high dynamic stress

Junkers vibration test according to DIN 65151

Screw M 10 (8.8) galvanically zinc coated

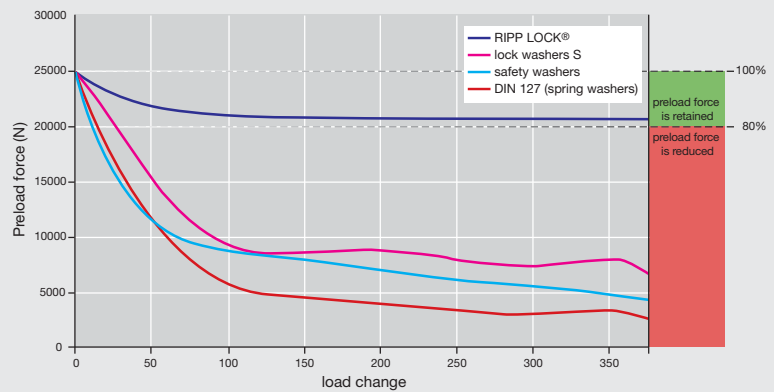

Gentle to contact surface – even to coated or powder coated surfaces

Aluminium



RIPP LOCK®



DIN 127

RIPP LOCK® lock washers

Benefits

Perfectly suitable also for slotted-hole applications



Very low fluctuation in preload-force at defined tightening torque

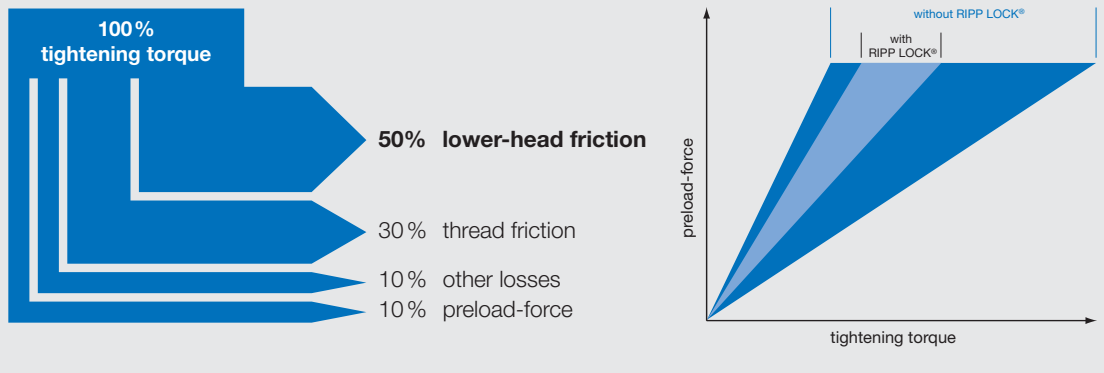

Universal use –
outside diameter = DIN 125/ISO 7089



Smaller external diameter for joints with
counterbored cheese head

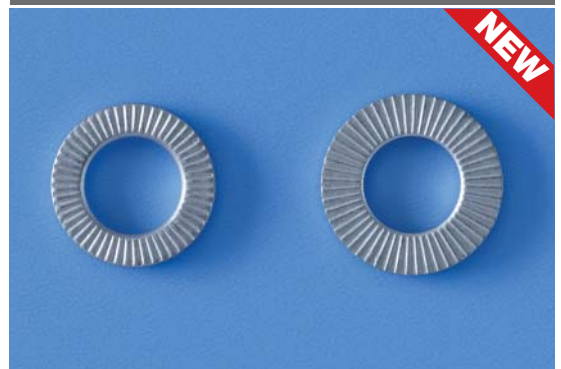

RIPP LOCK® lock washers**Further benefits**

- Easy assembly and removal – multiple reuse
- Economic benefits due to reduction and standardisation of assortment
- Small space requirements
- Not affected by contact with lubricants or greases
- Perfectly suitable for low-strength metals (aluminium, copper, aluminium and magnesium casting alloys, etc.)
- Suitable for all property classes up to 12.9
- Particularly suitable for sensitive surfaces such as zinc coated, chromium-plated, coated or powder coated surfaces
- Immediate effect – no curing
- Same temperature range as high-tensile screws
- Longevity – no ageing, no embrittling or weathering
- Almost no mechanical abrasion – no chip formation
- Retrofitting into almost every construction
- Effective in adjustable fastenings of components (e. g. prestressing of belt drive)
- Very small relaxation
- CAD data available on request
- The RIPP LOCK® defines friction values of most diverse materials and surfaces



RIPP LOCK® lock washers

Possible applications

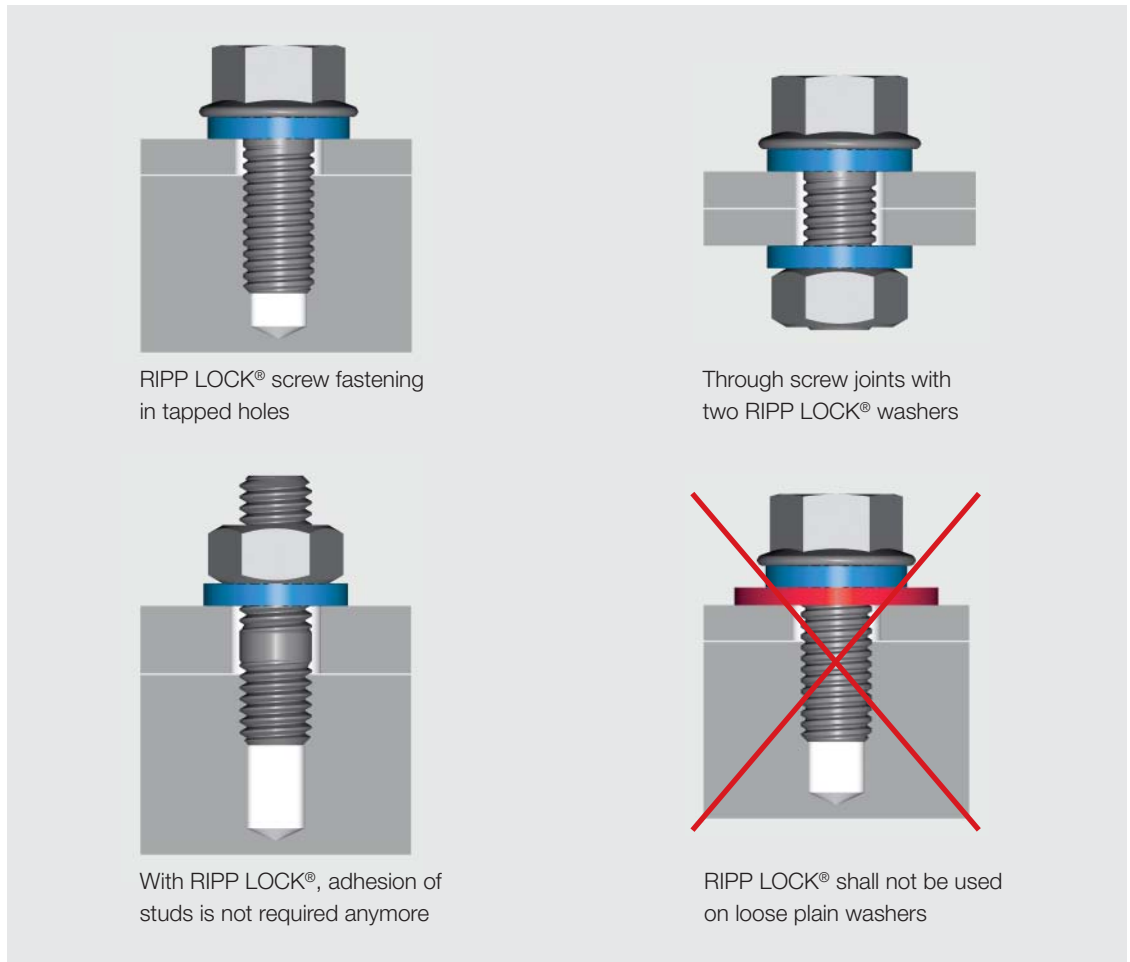

Tightening torques

To minimise creep and relaxation, screws with a large head support are used in many applications. However, particularly for light metals, friction values often are so high that the desired preload-forces are not achieved (see red lines in diagram). With the use of RIPP LOCK® lock washers which only allow a relative movement between screw head and washer, defined friction values and thus defined clamping forces are always achieved – even for most diverse materials and surfaces (see blue lines in diagram).

Getestet auf Aluminium

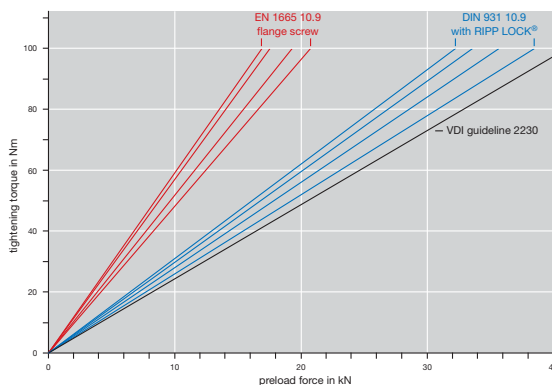

Tightening torques determined in accordance with VDI guideline 2230 (Association of German Engineers – VDI) can thus be applied to almost all other applications.



RIPP LOCK® lock washers

Technical information

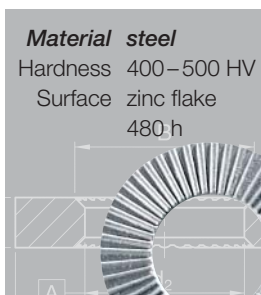
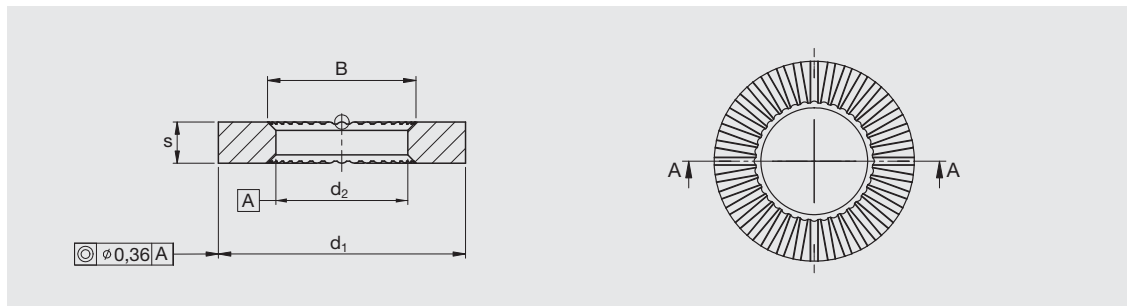

Size (nominal dimension)	Diameter of hole d ₂ min.	Outside diameter d ₁ max.	Thickness s nominal dimension	B max.	Order No
4	4.3	9	2.0	5.0	53065STZL4
5	5.3	10	2.0	6.0	53065STZL5
6	6.4	12	2.0	8.0	53065STZL6
8	8.4	16	2.5	10.0	53065STZL8
10	10.5	20	2.5	12.1	53065STZL10
12	12.5	24	3.0	14.1	53065STZL12
14	14.5	28	3.0	16.1	53065STZL14
16	16.5	30	4.0	18.1	53065STZL16
20	20.5	37	4.0	22.1	53065STZL20
24	24.5	44	5.0	26.1	53065STZL24
27	27,5	50	5,0	29,1	53065STZL27
30	30,5	56	5,0	32,1	53065STZL30

Smaller external diameter

Size (nominal dimension)	Diameter of hole d ₂ min.	Outside diameter d ₁ max.	Thickness s nominal dimension	B max.	Order No
6	6,4	11	2,0	8,0	53065STSZL6
8	8,4	15	2,5	10,0	53065STSZL8
10	10,5	18	2,5	12,1	53065STSZL10
12	12,5	20	3,0	14,1	53065STSZL12



Size (nominal dimension)	Diameter of hole d ₂ min.	Outside diameter d ₁ max.	Thickness s nominal dimension	B max.	Order No
4	4.3	9	2.0	5.0	53065A44
5	5.3	10	2.0	6.0	53065A45
6	6.4	12	2.0	8.0	53065A46
8	8.4	16	2.5	10.0	53065A48
10	10.5	20	2.5	12.1	53065A410
12	12.5	24	3.0	14.1	53065A412
16	16.5	30	4.0	18.1	53065A416

i All RIPP LOCK® lock washers comply with ELV, RoHS and WEEE directives and are thus chrome(VI)-free.

RIPP LOCK® lock screws and nuts



Special advantages

- Reliable fastening connections, no additional elements required
- Increased contact area makes washers and spring washers unnecessary
- Rounded locking ribs enable corrosion protection to be largely maintained at the fastening points, since the fastening does not damage the surface
- Reduced setting values for the screws because of cold working of the clamped materials
- Good tightening characteristics, excellent reusability

Because the ribs do not dig into the surface in the release direction, the fastening is gentle to sensitive surfaces. The damage to the surface around the contact area is minimal.

The diagram shows the principle of operation of these self-locking screws and nuts.

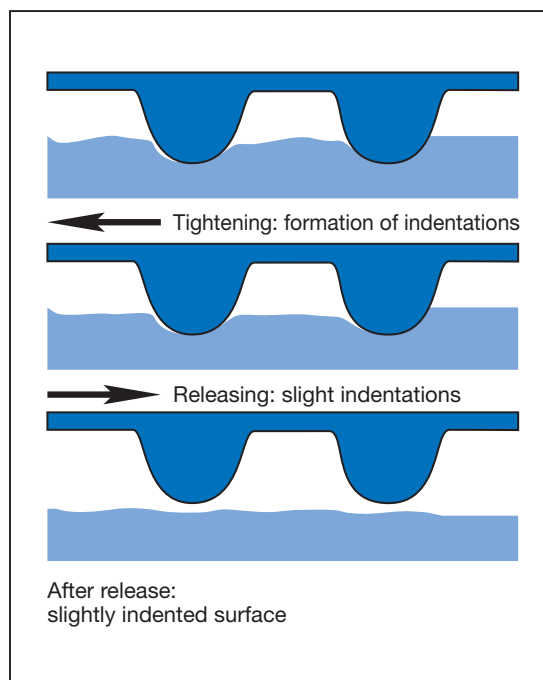

RIPP LOCK® lock screws and nuts

Design instructions

RIPP LOCK® self-locking screws and nuts are available as:

- Hexagon socket self-locking screws, property class 100
- Hexagon head self-locking screws, property class 100
- Hexagon head self-locking nuts, property class 10

For self-locking screws with hexagon socket heads, the head heights and hexagon sizes are identical to those for DIN 912 screws. To achieve a greater contact area the head diameter is slightly increased. This results in a reduced surface pressure.

Property classes

- Self-locking screws 100 = 1,040 N/mm²
- Self-locking nuts 10: for screws up to property class 10.9 and screw class 100
- Property classes 12.9 and 12 available on request

Hardness

- Hardness at the edge amounts 400 – 500 HV

Mechanical features of the RIPP LOCK® locking screws and locking nuts

Tightening torque M_A (Nm) and achieving preload force F_M (kN) for RIPP LOCK® locking screws and locking nuts when using 90 % of the yield strength $R_{p0,2}$.

Strength class	Counterpart material	M 5	M 6	M 8	M 10	M 12	M 16
Strength class screws100 nuts 10	Steel $R_m = < 800 \text{ N/mm}^2$	11	19	42	85	130	330
	Steel $R_m = > 800 \text{ N/mm}^2$	10	18	37	80	120	300
	Gray cast iron	9	16	35	75	115	300
	Indications for achievable preload forces have to be checked in practice	Preload force F_M (kN)					
		9.0	12.6	23.2	37.0	54.0	102.0

RIPP LOCK® lock screws and nuts

Counterbore dimensions

The counterbore dimensions for fitting these screws are set out in DIN 74, part 2.

Threads	M 5	M 6	M 8	M 10	M 12	M 16
d ₁ Through hole average size (m) ¹⁾	5.5	6.6	9.0	11.0	13.5	17.5
d ₂ Counterbore diameter ²⁾	12.5	14.5	19.0	21.5	24.5	33.0
t Counterbore depth ²⁾	5.7	6.8	9.0	11.0	13.0	16.0

¹⁾ Through hole average size to DIN ISO 273

²⁾ to DIN 74, part 2

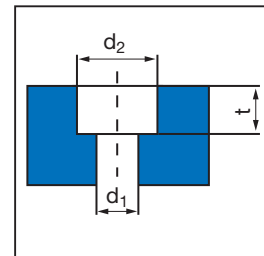

The diagram below shows the fastening behaviour of screws in a shake test.

The dashed line shows the behaviour of an unlocked screw, the continuous lines the behaviour of screws with spring washers to DIN 127 and serrated lock washers to DIN 6798.

The blue line indicates the behaviour of a screw with locking teeth or locking ribs.

(see also page 4 – Junkers vibration test)

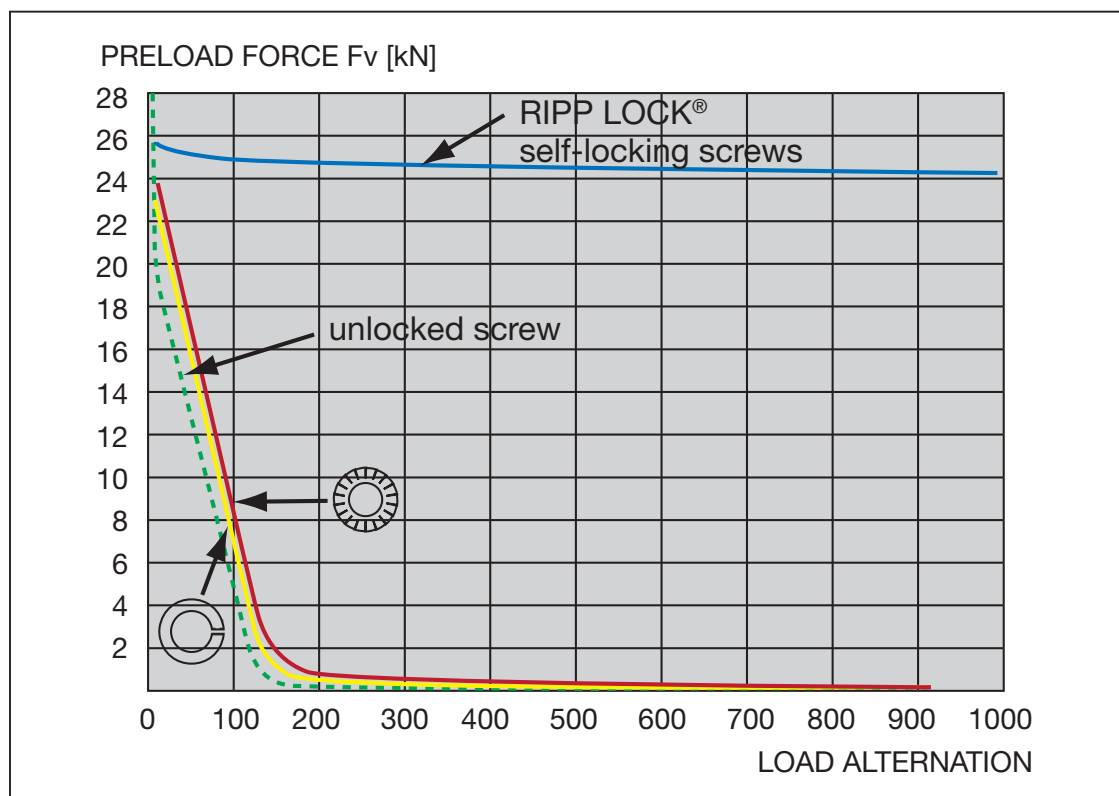

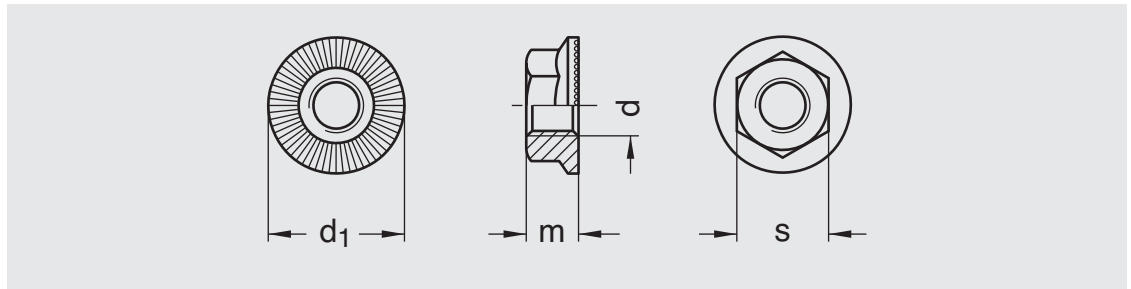
RIPP LOCK® lock screws and nuts
Technical information

RIPP LOCK® locknuts, strength class 10

Size	d ₁	s	m	Order No
M 5	11.20	8	4.3	W1931005
M 6	14.25	10	5.5	W1931006
M 8	18.20	13	7.0	W1931008
M 10	21.00	15	8.5	W19310010
M 12	24.00	17	10.0	W19310012
M 16	31.00	22	14.0	W19310016

RIPP LOCK® locknuts, strength class 10, zinc plated

Size	d ₁	s	m	Order No
M 5	11.20	8	4.3	W193100VZ5
M 6	14.25	10	5.5	W193100VZ6
M 8	18.20	13	7.0	W193100VZ8
M 10	21.00	15	8.5	W193100VZ10
M 12	24.00	17	10.0	W193100VZ12
M 16	31.00	22	14.0	W193100VZ16

RIPP LOCK® locknuts, strength class 10, zinc plated, yellow passivated

Size	d ₁	s	m	Order No
M 6	14.25	10	5.5	W193100VG6
M 8	18.20	13	7.0	W193100VG8
M 10	21.00	15	8.5	W193100VG10
M 12	24.00	17	10.0	W193100VG12
M 16	31.00	22	14.0	W193100VG16



All RIPP LOCK® locknuts (except yellow passivated) comply with ELV, RoHs and WEEE directives and are thus chrom(VI)-free.
Further surfaces and dimensions on request.

RIPP LOCK® lock screws and nuts

Technical information

RIPP LOCK® lock screws, strength class 100

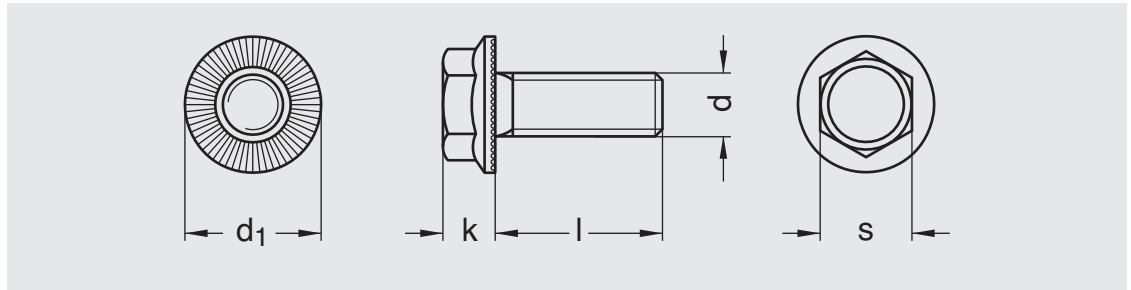

Size	s	k	d ₁
M 5	8	4.3	11.2
M 6	10	5.5	14.2
M 8	13	7.0	18.2
M 10	15	8.5	21.0
M 12	17	10.0	24.0
M 16	22	14.0	31.0

Size	l	Order No	Size	l	Order No
M 5	10	W158100510	M 10	22	W1581001022
M 5	12	W158100512	M 10	25	W1581001025
M 5	14	W158100514	M 10	30	W1581001030
M 5	16	W158100516	M 10	35	W1581001035
M 6	10	W158100610	M 10	40	W1581001040
M 6	12	W158100612	M 12	20	W1581001220
M 6	14	W158100614	M 12	25	W1581001225
M 6	16	W158100616	M 12	30	W1581001230
M 6	18	W158100618	M 12	35	W1581001235
M 6	20	W158100620	M 12	40	W1581001240
M 6	25	W158100625	M 12	45	W1581001245
M 6	30	W158100630	M 12	50	W1581001250
M 8	12	W158100812	M 12	55	W1581001255
M 8	14	W158100814	M 16	25	W1581001625
M 8	16	W158100816	M 16	30	W1581001630
M 8	18	W158100818	M 16	35	W1581001635
M 8	20	W158100820	M 16	40	W1581001640
M 8	25	W158100825	M 16	45	W1581001645
M 8	30	W158100830	M 16	50	W1581001650
M 8	35	W158100835	M 16	55	W1581001655
M 8	40	W158100840	M 16	60	W1581001660
M 10	16	W1581001016	M 16	70	W1581001670
M 10	18	W1581001018	M 16	80	W1581001680
M 10	20	W1581001020	M 16	85	W1581001685



All RIPP LOCK® locking screws comply with ELV, RoHs and WEEE directives and are thus chrom(VI)-free.
Further surfaces and dimensions on request.

RIPP LOCK® lock screws and nuts

Technical information

RIPP LOCK® lock screws, strength class 100, zinc plated

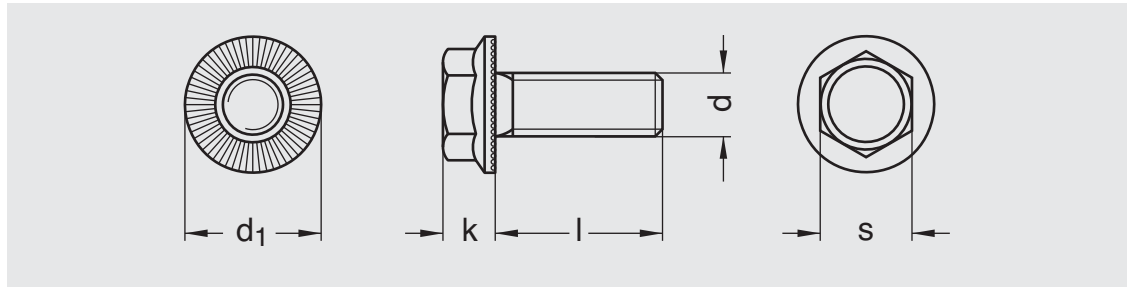

Size	s	k	d ₁
M 5	8	4.3	11.2
M 6	10	5.5	14.2
M 8	13	7.0	18.2
M 10	15	8.5	21.0
M 12	17	10.0	24.0
M 16	22	14.0	31.0

Size	l	Order No	Size	l	Order No
M 5	10	W158100VZ510	M 10	30	W158100VZ1030
M 5	12	W158100VZ512	M 10	35	W158100VZ1035
M 5	16	W158100VZ516	M 12	20	W158100VZ1220
M 6	10	W158100VZ610	M 12	25	W158100VZ1225
M 6	12	W158100VZ612	M 12	30	W158100VZ1230
M 6	14	W158100VZ614	M 12	35	W158100VZ1235
M 6	16	W158100VZ616	M 12	40	W158100VZ1240
M 6	20	W158100VZ620	M 12	45	W158100VZ1245
M 6	25	W158100VZ625	M 12	50	W158100VZ1250
M 8	12	W158100VZ812	M 16	25	W158100VZ1625
M 8	14	W158100VZ814	M 16	30	W158100VZ1630
M 8	16	W158100VZ816	M 16	35	W158100VZ1635
M 8	20	W158100VZ820	M 16	40	W158100VZ1640
M 8	25	W158100VZ825	M 16	45	W158100VZ1645
M 8	35	W158100VZ835	M 16	50	W158100VZ1650
M 8	40	W158100VZ840	M 16	55	W158100VZ1655
M 10	16	W158100VZ1016	M 16	60	W158100VZ1660
M 10	20	W158100VZ1020	M 16	70	W158100VZ1670
M 10	25	W158100VZ1025			

i All RIPP LOCK® locking screws comply with ELV, RoHs and WEEE directives and are thus chrom(VI)-free. Further surfaces and dimensions on request.

RIPP LOCK® lock screws and nuts

Technical information

RIPP LOCK® lock screws with hexagon socket, strength class 100

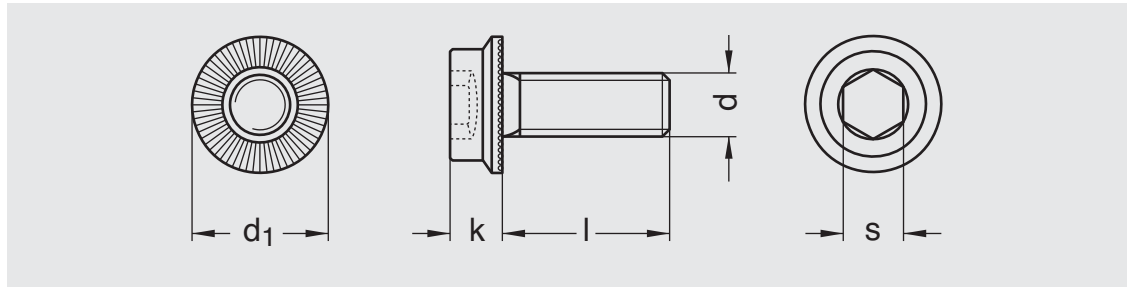

Size	s	d ₁ max.	k max.
M 5	4	11.0	5
M 6	5	13.5	6
M 8	6	17.0	8
M 10	8	19.5	10
M 12	10	22.5	12

Size	l	Order No	Size	l	Order No
M 5	10	W251100510	M 8	40	W251100840
M 5	12	W251100512	M 10	16	W2511001016
M 5	16	W251100516	M 10	20	W2511001020
M 5	20	W251100520	M 10	25	W2511001025
M 6	10	W251100610	M 10	30	W2511001030
M 6	12	W251100612	M 10	35	W2511001035
M 6	16	W251100616	M 10	40	W2511001040
M 6	20	W251100620	M 12	20	W2511001220
M 6	25	W251100625	M 12	25	W2511001225
M 6	30	W251100630	M 12	30	W2511001230
M 8	12	W251100812	M 12	35	W2511001235
M 8	16	W251100816	M 12	40	W2511001240
M 8	20	W251100820	M 12	45	W2511001245
M 8	25	W251100825	M 12	50	W2511001250
M 8	30	W251100830			

i All RIPP LOCK® locking screws comply with ELV, RoHs and WEEE directives and are thus chrom(VI)-free.
Further surfaces and dimensions on request.

RIPP LOCK® lock screws and nuts

Technical information

RIPP LOCK® lock screws with hexagon socket, strength class 100, zinc plated

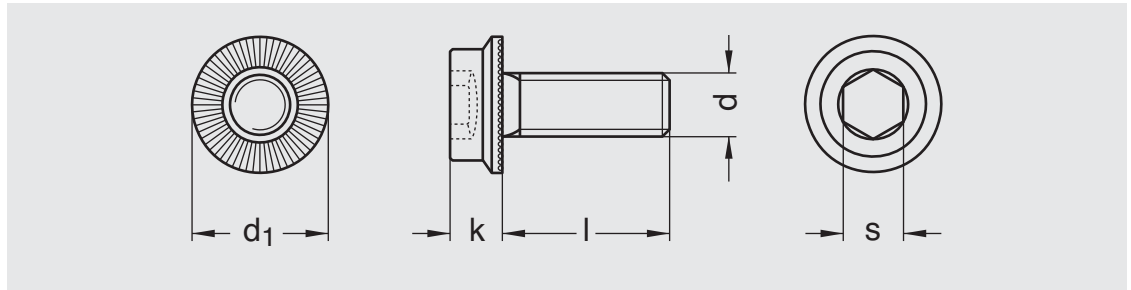

Size	s	d ₁ max.	k max.
M 5	4	11.0	5
M 6	5	13.5	6
M 8	6	17.0	8
M 10	8	19.5	10
M 12	10	22.5	12

Size	l	Order No	Size	l	Order No
M 5	10	W251100VZ510	M 8	30	W251100VZ830
M 5	12	W251100VZ512	M 8	40	W251100VZ840
M 5	16	W251100VZ516	M 10	20	W251100VZ1020
M 5	20	W251100VZ520	M 10	25	W251100VZ1025
M 6	12	W251100VZ612	M 10	30	W251100VZ1030
M 6	16	W251100VZ616	M 10	35	W251100VZ1035
M 6	20	W251100VZ620	M 10	40	W251100VZ1040
M 6	25	W251100VZ625	M 12	30	W251100VZ1230
M 6	30	W251100VZ630	M 12	35	W251100VZ1235
M 8	16	W251100VZ816	M 12	40	W251100VZ1240
M 8	20	W251100VZ820	M 12	45	W251100VZ1245
M 8	25	W251100VZ825	M 12	50	W251100VZ1250



All RIPP LOCK® locking screws comply with ELV, RoHs and WEEE directives and are thus chrom(VI)-free.
Further surfaces and dimensions on request.

Böllhoff International with companies in:

Argentina
Austria
Brazil
Canada
China
Czech Republic
France
Germany
Hungary
India
Italy
Japan
Korea
Mexico
Poland
Romania
Russia
Slovakia
Spain
Switzerland
Turkey
United Kingdom
USA

Apart from these 23 countries, Böllhoff supports its international customers in other important industrial markets in close partnership with agents and dealers.



Made of paper certified with the Ecolab of the European Community (Reg No. FR/11/003).
Printed by FSC®-certified company GFA-COC-001790.

Subject to technical change.
Reprinting, even in extract form, only permitted with express consent.
Observe protective note according to ISO 16016.

KEL Bulgaria Ltd.
Please find your local contact on www.kelbulgaria.com
or contact us under info@kelbulgaria.com
Telephone: +359 877008832
Fax: +359 24922552

